

**DEVELOPMENT OF BUS TRAVEL TIME MODEL UNDER  
HETEROGENEOUS TRAFFIC FLOW APPLYING DYNAMIC  
NEURAL NETWORKS-KALMAN FILTER ALGORITHM: THE  
CASE OF DAR ES SALAAM CITY IN TANZANIA**

**Prosper Sebastian Nyaki**

**PhD. (Transportation Engineering) Thesis**

**University of Dar es Salaam**

**April 2021**

**DEVELOPMENT OF BUS TRAVEL TIME MODEL UNDER  
HETEROGENEOUS TRAFFIC FLOW APPLYING DYNAMIC  
NEURAL NETWORKS-KALMAN FILTER ALGORITHM: THE  
CASE OF DAR ES SALAAM CITY IN TANZANIA**

**By**

**Prosper Sebastian Nyaki**

**A Thesis Submitted in Fulfilment of the Requirement for the Degree of Doctor  
of Philosophy (Transportation Engineering) of the University of Dar es Salaam**

**University of Dar es Salaam**

**April 2021**

## CERTIFICATION

The undersigned certify that they have read and hereby recommend for examination by the University of Dar es Salaam a thesis entitled: *Development of Bus Travel Time Model Under Heterogeneous Traffic Flow Applying Dynamic Neural Networks-Kalman Filter Algorithm: The Case of Dar es Salaam City in Tanzania*, in fulfilment of the requirement for the degree of Doctor of Philosophy (Transportation Engineering) of the University of Dar es Salaam

.....

Prof. Nurdin K. M. Mushule

(Supervisor)

Date: .....

.....

Prof. Hannibal Bwire

(Supervisor)

Date: .....

## **DECLARATION AND COPYRIGHT**

I, **Prosper Sebastian Lemara Nyaki**, declare that this thesis is my own original work and that it has not been presented and will not be presented to any other University for a similar or any other degree award.

**Signature** -----

©2020

This thesis is a copyright material protected under the Berne Convention, the Copyright Act 1999 and other international and national enactments, in that behalf, on intellectual property. It may not be reproduced by any means, in full or in part, except for short extracts in fair dealings, for research or private study, critical scholarly review or discourse with an acknowledgment, without a written permission of the Director of Postgraduate Studies, on behalf of both the author and the University of Dar es Salaam.

## **ACKNOWLEDGEMENT**

I am very thankful to our Almighty God for granting me the time, health and courage to go through this research. I am taking this opportunity to express my sincere gratitude to everyone who, in one way or another, supported me in pursuing PhD studies. I would like to express my sincere appreciation to my supervisors Prof. Nurdin K. M. Mushule and Prof. Hannibal Bwire for their invaluable academic and scientific support as well as for their constructive guidance throughout my doctoral work.

I also wish to express my sincere appreciation to my colleagues at the University of Dar es Salaam (UDSM) and the technical and academic staff of the Transportation and Geotechnical Engineering Department, UDSM, for their support during my study. It would be insufficient if the moral and social support offered by friends, relatives and colleagues at UDSM is not acknowledged. I would like to extend my thanks to my employer, the National Institute of Transport, especially to Prof. Zakaria Mganilwa, Alex Butogo and Dr. Robert Msigwa for helping me with experimental work.

I am very grateful to my beloved, wife, Mrs. Angela, my parent Mr. Sebastian and my brothers and sisters for their invaluable support. Lastly, to my beloved, and wonderful daughter Doreen, and sons Sebastian and Isaac, who have always been my inspiration. Thank you!

## **DEDICATION**

This thesis is dedicated to my wife Angela and my Father, Mr. Sebastian Nyaki and particularly in loving memory of my late Mother, Teresia Sebastian Nyaki for her sacrifice in sending me to school.

## **ABSTRACT**

The growth of population and economic activities in many cities worldwide cause multiple problems related to urban transport. The social transformation has increased the urban mobility that leads to the increase of private cars and urban sprawl. Many urban transport systems today experience increasing congestion that threatens the quality of life and transport efficiency. Most researchers conclude that the provision of traffic flow information to road users is among the strategies to alleviate urban congestion. Providing real and accurate travel time information usually helps road users plan their trips and choice of appropriate mode of transport. However, precise prediction of travel time is a challenging problem, especially in developing countries where heterogeneous flow conditions exist and there are no records of information about the travel time for travellers. A limited number of studies have been performed under heterogeneous traffic conditions, and none of the existing models take into account stochastic waiting at the bus stops and delays at the intersections. To address this gap in knowledge, this research developed a dynamic travel time prediction model to determine travel time reliability and assess the delay distribution at the intersections under heterogeneous traffic flow conditions in the developing countries.

The primary data were collected from public transport (commuter buses known as Daladala) using smartphones and stopwatches. The delay time at the intersections and waiting time at bus stops was collected through field observation at the intersection and the bus stop areas. Secondary data (traffic flow data) collected by the Japan International Cooperation Agency (JICA) in collaboration with the National Institute of Transport (NIT), was obtained from the NIT database.

The dynamic travel-time prediction model was developed by comparing Multiple Linear Regression and Artificial Neural Network models using waiting time at intersections, bus waiting time, and waiting time at bus stops, link distance, peak and off-peak hours, traffic volume, and travel time as input variables. The models were compared in terms of their performance using R-squared, Mean Absolute Percentage Error, and Root Mean Square Error, and the Artificial Neural Network model outperformed the Multiple Linear Regression model. The Artificial Neural Network model was then integrated with a Kalman filtering dynamic algorithm to produce an Artificial Neural Network-Kalman Filter Algorithm Dynamic model. Model accuracy was tested using R-squared, Mean Absolute Percentage Error, and Root Mean Square Error. Overall results revealed that the Artificial Neural Network-Kalman Filter Algorithm model produced minimum error, and therefore, could be applied to predict travel time under heterogeneous traffic conditions. Moreover, the research evaluated travel time reliability in terms of travel time in the route links, waiting time at the bus stops, and delay time at the intersections. Four techniques were applied: buffer time, standard deviation, coefficient of variation, and planning time. The overall results indicated low service reliability in the outbound directions compared to inbound directions.

Finally, the delay distribution at the intersections was determined. The delay time distribution was evaluated under three scenarios of traffic flow conditions: a) entire delay (inbound and outbound), b) off-peak hours (inbound and outbound), and c) peak hours (inbound and outbound). Results indicated that during the outbound peak hours, about 80% of cars spent between two and nine minutes to cross each intersection, followed by outbound off-peak, inbound peak, and lastly, inbound off-



peak. In general, about 75% of cars spend two to nine minutes to cross the intersections for outbound directions, compared to 65% of cars for the inbound directions, because for the outbound directions, especially during peak hours, most people leave the city centre within the same period of time, which results in an influx of traffic flow along the five main corridors in the city.

It is recommended that the model developed, travel time reliability determination and delay distribution at intersections should undergo further testing and validation, using comprehensive data from Dar es Salaam city to improve their reliability for future applications.

## TABLE OF CONTENTS

CERTIFICATION .....	i
DECLARATION AND COPYRIGHT .....	ii
ACKNOWLEDGEMENT .....	iii
DEDICATION .....	iv
ABSTRACT .....	v
TABLE OF CONTENTS .....	viii
LIST OF FIGURES .....	xiii
LIST OF TABLES .....	xv
LIST OF ABBREVIATIONS AND ACRONYMS .....	xvi
SYMBOLS, VARIABLES AND PARAMETERS .....	xviii
CHAPTER 1 – INTRODUCTION.....	1
1.1 Background .....	1
1.2 Statement of the Problem .....	6
1.3 Research Objective .....	7
1.4 Research Significance .....	8
1.5 Scientific Contribution .....	9
1.6 Organization of this Thesis.....	10
CHAPTER 2-LITERATURE REVIEW .....	12
2.1 Introduction.....	12
2.2 Urban Travel Time Prediction.....	13
2.2.1 Model-Based Methods .....	14
2.2.1.1 Queue Theory Based Model.....	14
2.2.1.2 Traffic Flow Theory Model.....	15
2.2.1.3 Cumulative Vehicle Count Model.....	17

2.2.1.4 Time-Dependent Arterial Model .....	19
2.2.2. Pure Data-Driven Methods.....	20
2.2.2.1 Historical Data Models.....	21
2.2.2.2 Time Series Models.....	22
2.2.2.3 Regression Models .....	22
2.2.2.4 Artificial Neural Network Models (ANN) .....	23
2.2.2.5 Limitation of Artificial Neural Network .....	25
2.2.2.6 Kalman Filtering Model (KF) .....	26
2.2.3 Dynamic Travel Time .....	27
2.2.4 ANN and KF Dynamic Model .....	29
2.3 Route Travel Time Reliability.....	30
2.3.1 Measure of Travel Time Reliability .....	34
2.3.2 Standard Deviation .....	36
2.3.3 Coefficient of Variation.....	36
2.3.4 Percentile Value .....	37
2.3.5 Buffer time .....	37
2.3.6 Buffer Index (BI).....	38
2.3.7 Planning Time Index (PTI).....	39
2.3.8 Tardy Trip Measures .....	40
2.3.9 Probabilistic Measures .....	40
2. 4. Delay Time Variation at the Intersection .....	42
2.4.1. Background of Delay Time .....	42
2.4.1.1 Control Delay .....	43
2.4.1.2 Approach Delay.....	43
2.4.1.3 Stopped-Time Delay.....	44
2.4.1.4 Running Time Delay .....	44
2.4 2 Theory of Delay Variability .....	44
2.4.3 Measure of Delay Variation at the Intersections .....	46
2.4.4 Delay Time Variations Analysis .....	49
2.4.4.1 Deterministic Queuing Model .....	50
2.4.4.2 Calculation of Uniform Delay Model .....	52

2.4.4.3 Random Delay .....	53
2.4.4.4 Random Delay Model .....	54
2.4.4.5 Overflow Delay .....	56
2.5 Travel Time Measures .....	58
2.5.1 Measure Techniques of Travel Time.....	59
2.5.2 Point Sensors .....	59
2.5.3 Double-loop Detectors .....	60
2.6 Urban Travel Time Conceptual Framework .....	65
2.6.1 Summary .....	66
2.6.2 Literature gaps .....	66
2.6.3 Methodological gaps .....	67
CHAPTER 3 – STUDY AREA AND DATA COLLECTION.....	68
3.1 Description of the Study Area .....	68
3.1.1 Study Area Location.....	68
3.1.2 Survey Corridors .....	70
3.2 Research Methodology.....	70
3.2.1 Data Collection Methods.....	71
3.2.2 Survey Duration .....	72
3.2.3 Data Collection Procedures.....	73
3.2.4 Surveyors Training .....	74
3.2.5. Sample Size .....	75
3.2.6 Pilot Survey.....	76
3.3 Data Collection.....	76
3.3.1 Primary Data Collected.....	77
3.3.2 Secondary Data .....	78
3.3.3 Data Collection Instrument.....	82
3.3.4 Data Processing .....	83
3.4 Development of Urban Travel Time Model.....	84
3.4.1 Dynamic Travel Time Model .....	85
3.4.2 Data Descriptions .....	86
3.4.3 Multi-Linear Regression (MLR) Model.....	87

3.4.4 Model Input Data.....	87
3.4.5 Model Performance .....	88
3.4.6 Artificial Neural Network .....	89
3.4.6.1 The Network Architecture.....	90
3.4.6.2 ANN for Travel Time Prediction .....	92
3.4.6.3 XLSTAT Software .....	93
3.4.7 Dynamic Model Descriptions.....	98
3.4.7.1 Kalman Filter Dynamic Algorithm .....	99
3.4.7.2 Model Performance .....	102
3.4.7.3 Model validation.....	102
3.5. Establishment of Travel Time Reliability .....	103
3.5.1 The Concept of Travel Time Reliability .....	103
3.5.2 Reliability Definitions .....	104
3.5.3 Analysis of Travel Time Reliability.....	104
3.5.4 Statistical Range Methods .....	104
3.5.4.1 Standard Deviation (STD).....	105
3.5.4.2 Coefficient of Variation (CV) .....	105
3.5.4.3 95 <sup>th</sup> Percentile Travel Time .....	106
3.5.5 Buffer Travel Time.....	106
3.5.5.1 Buffer Index .....	107
3.5.6 Data Used.....	108
3.5.6.1 Determine Travel Time Reliability .....	110
3.6 Delay Variation Distribution at the Intersection .....	111
3.6.1 Introduction .....	111
3.6.2 The Concept of Modeling Delay Variability at Intersections .....	112
3.6.2.1 Intersection Delay Time Model.....	115
3.6.2.2 Determine Delay Time Variation at the Intersection .....	117
3.6.2.3 Determine of Delay Time Variation.....	118
3.6.2.4 Determine Normal Delay Distribution .....	120
CHAPTER 4 – RESEARCH FINDINGS AND DISCUSSION .....	124
4.1 Introduction .....	124

4.2 Development of the Dynamic Travel Time Model .....	124
4.2.1 Similarities of Traffic Flow per Week .....	125
4.2.2. Model Performance and Evolution.....	126
4.2.2.1 Comparison of MLR and ANN Models .....	126
4.2.2.2 Comparison of ANN and ANN-Kalman Filter (ANN-KF) Models.....	128
4.2.2.3 Model Validation.....	129
4.3 Route Travel Time Reliability.....	132
4.3.1 Day-to-day Travel Time Variability.....	133
4.3.2 In-Vehicle Buffer Time .....	134
4.3.3 In-Vehicle Planning Time .....	135
4.3.4 Route Buffer Time Index and Planning Time Index .....	136
4.3.5 Waiting Time Reliability at Bus Stops and Intersections.....	137
4.3.6 Bus Stops based on Standard Deviations and Buffer Time.....	138
4.4 Delay Variation Distribution at the Intersections .....	139
CHAPTER 5 – CONCLUSION AND RECOMMENDATIONS.....	150
5.1 Introduction .....	150
5.2 Conclusion.....	150
5.2.1 Literature Review .....	151
5.2.2 Dynamic Urban Travel Time Prediction Model.....	152
5.2.2.1 Model Validation.....	153
5.2.2.2 Model Performance .....	153
5.2.3 Travel Time Reliability .....	153
5.2.4 Delay Variation at the Intersections .....	154
5.3. Practical Usability of the Results .....	154
5.4 Policy Implications .....	155
5.5 Recommendations .....	157
REFERENCES .....	160
APPENDICES .....	176

## LIST OF FIGURES

Figure 1.1: Factors Influencing Urban Travel Time Variability .....	4
Figure 2.1: Traffic Flow Cumulative .....	17
Figure 2.2: Delay Types at a Signalized Intersection .....	42
Figure 2.3: Uniform Delay Time at the Intersection.....	51
Figure 2.4: Delay Time in Random Traffic at the Intersections .....	54
Figure 2.5: Delay Time over Traffic Flow.....	56
Figure 2.6: Traffic Source Data; Point Sensor.....	60
Figure 2.7: Double-loop Detectors.....	61
Figure 2.8: Traffic Source Data; Probe Sensor .....	62
Figure 2.9: Traffic Source Data; Interval Sensor.....	63
Figure 2.10: Urban Travel Time Model Concept.....	66
Figure 3.1: Main Corridors in Dar es Salaam City .....	69
Figure 3.2: Traffic Count Points in Dar es Salaam City .....	79
Figure 3.3: Primary and Secondary Data Collected in all directions.....	82
Figure 3.4: Dynamic travel time prediction Framework.....	86
Figure 3.5: The Artificial Neural Network Architecture .....	91
Figure 3.6: XLSTAT Software .....	93
Figure 3.7: Artificial Neural Network Activation Function.....	94
Figure 3.8: Artificial Neural Networks Model Training Process.....	95
Figure 3.9: Artificial Neural Network Model .....	97
Figure 3.10: ANN-KF model application .....	101
Figure 3.11: Schematic diagram of traffic flow at the intersection.....	113
Figure 3.12: Changing Delay Time at Intersection.....	118
Figure 3.13: Delay Variation Distribution Analyses .....	120
Figure 3.14: XLSTAT software delay variation through distribution curve .....	122
Figure 4.1: Travel Time Variation Inbound Directions .....	126
Figure 4.2: Travel Time Variation Outbound Directions.....	126
Figure 4.3 (a), (b): ANN Inbound and Kalman Filter Inbound.....	128
Figure 4.3 (c), (d): ANN Outbound and Kalman Filter Outbound .....	129
Figure 4.4 (a): Comparison observed and predicted outbound travel time.....	130

Figure 4.4 (b): Comparison observed and predicted outbound travel time.....	131
Figure 4.5: In-vehicle Buffer Time in Dar es Salaam City .....	135
Figure 4.6: In-Vehicle Planning Time in Dar Es Salaam City.....	136
Figure 4.7: Buffer Time and Planning Time Index.....	137
Figure 4.8: Buffer time at the Bus Stops and Intersections.....	138
Figure 4.9: Delay distribution in inbound and outbound directions .....	143
Figure 4.10: Inbound off-peak and Peak Hours Delay Distribution .....	146
Figure 4.11: Outbound off-peak and Peak Hours Delay Distribution .....	147



## LIST OF TABLES

Table 2.1: Factors Affecting Reliability.....	32
Table 3.1: Districts of Dar es Salaam.....	68
Table 3.2: Traffic Flow Count Points .....	72
Table 3.3: Surveyed Area and Duration.....	73
Table 3.4: The Proposed Sample Size.....	76
Table 3.5: The Corridors and their attributes .....	77
Table 3.6: Heterogeneity of traffic flow in Dar es Salaam .....	81
Table 3.7: Data Collection Tools .....	82
Table 3.8: Specific Objectives and Data Required .....	84
Table 3.9: Data Description .....	87
Table 3.10: Survey Links and Time.....	109
Table 3.11: The Main Feature in the Five Corridors .....	110
Table 3.12: Surveyed Intersections in Five Main Corridors .....	120
Table 4.1: Travel Time Independent and Dependent Variables .....	125
Table 4.2: Weekly Travel Time Descriptive Statistics .....	125
Table 4.3: Comparison between MLR and ANN Models.....	127
Table 4.4 (b) : Comparison of Prediction Errors for two Models.....	132
Table 4.5: Travel Time Independent and Dependent Variables .....	133
Table 4.6: Average Travel Time and Standard Deviation at Route Levels .....	133
Table 4.7: Number of Intersections in Five Main Corridors.....	139
Table 4.8: Delay Variation in Five Main Corridors.....	140
Table 4.9: Delay Time Distribution at the Intersections .....	148

## **LIST OF ABBREVIATIONS AND ACRONYMS**

ANN	Artificial Neural Network
ANN-KF	Artificial Neural Network – Kalman Filter
ANPR	Automatic Number Plate Recognition
APC	Automatic Passenger Counter
BI	Buffer Index
BTI	Buffer Time Index
CBD	Central Business District
CV	Coefficient of Variation
DSM	Dar es Salaam
FDOT	Florida Department of Transportation
FHWA	Federal Highway Administration
GPS	Global Positioning System
HA	Historical Average
HCM	Highway Capacity Manual
ILD	Inductive Loop Detector
ITS	Intelligent Transportation Systems
JICA	Japan International Cooperation Agency
KF	Kalman Filtering
LOS	Level of Service
MAE	Mean Absolute Error
MAPE	Mean Absolute Per cent age Error
MI	Misery Index

MLP	Multilayer Perceptron
MLR	Multiple Linear Regression
NIT	National Institute of Transport
NN	Neural Network
OECD	Organization for Economic Co-operation and Development
Pd(.)	Delay Probability Function
PFD	Probabilistic Function Distribution
PTI	Planning Time Index
PT	Planning Time
RBF	Radial Basis Function
RBFNN	Radial Basis Function Neural Networks
RMSE	Root Mean Square Error
STD	Standard Deviation
SVR	Support Vector Regression
TTR	Travel Time Reliability
VISSIM	Verkehr In Städten SI Mulationsmode (Software)

## SYMBOLS, VARIABLES AND PARAMETERS

C	Cycle Time
D	Average Delay Time of Vehicle per Cycle
g	Green Time
$K(x,t)$	Density at Instant t and Location x
L	Link Length
L <sub>q</sub>	Queue Length
M	Kalman Filter Coefficient
M	Mean Travel Time
n <sub>0</sub>	Initial Queue
N <sub>q</sub>	Number of Vehicles in the Queue
OD	Overflow Delay
q	Flow Rate
$q(x,t)$	Traffic volume at Instant Time t and Location x
r	Red Time
R	R-Square
RD	Average Random Delay
s	Saturated Rate Vehicle
T1	Traffic Volume at Instant Time t and Location x
T2	Exit Time
T <sub>g</sub>	Green Phase Time
T <sub>r</sub>	Red Phase Time
TT	Vehicle Travel Time

$TT_{ob}$	Observed Travel Time
$TT_{pred}$	Predicted Travel Time
$UD$	Average Uniform Delay
$U_f$	Free Flow Speed
$V$	Road Capacity
$x$	Degree Saturation
$X_t$	Kalman Filter Unobserved Variable
$Y_t$	Kalman Filter Observable Variable
$\theta$	Process Disturbance Noises

## CHAPTER 1–INTRODUCTION

### 1.1 Background

The growth of economic activities in cities worldwide causes multiple problems related to urban congestion. This social transformation has increased urban mobility, leading to an increase of private cars and urban sprawl. Today, many urban transport systems experience increasing congestion that threatens the quality of life and transport efficiency. The mechanism of traffic propagation along urban networks is quite different from that on the freeway. Traffic flows on freeways are often treated as uninterrupted, while urban networks are considered to have interrupted flows. Vehicles operating in urban road networks are subjected to not only queue delay, but also to delay at intersections (e.g., traffic lights and traffic police) and delay time at bus stops (i.e., unknown waiting times and limited parking bays), as well as delays caused by vehicles entering from sides streets (Fan and Gurmu, 2015). Applying travel time prediction models developed for freeways directly to urban networks may not produce reliable results. Various technologies have been used to provide travel time information to road users, such as fixed detectors, where the fixed traffic detection employed in roadway networks are stationary detectors (e.g., loop detectors) installed at specific road segment locations. They continuously record all vehicles passing through the road segments, as well as recording travel speed and traffic volume. The limitation of this method is the high cost of installation and maintenance. Furthermore, fixed traffic detectors cover a small urban area, while mobile sensors (floating car systems) are used to collect traffic flow data at any point or predefined checkpoint along a travel route.

Moreover, many scholars believe that by increasing road capacity, such as widening roads, building flyovers, and introducing rapid mass transit, at a certain level, urban congestion will be minimized (Peng et al., 2016 Jain et al., 2012). However, urban environments are limited to further widening of roadway networks.

Furthermore, other studies indicate that providing travellers with information, using Intelligent Transportation Systems (ITS), has shown a positive impact in reducing urban congestion (Kumar et al., 2017; Anil et al., 2017). ITS provides reliable information to road users, transport operators, and transport planners, which helps them to make appropriate decisions on how better to utilize and improve the use of existing road infrastructures.

Providing travel time information to road users enables them to better decide their travel choices (e.g., mode of transport, route to use, and departure time). Urban commuters are very interested in knowing which route or mode to use that will provide a shorter travel time (Wu et al., 2019). Providing travel time information to passengers helps them in planning their trips and minimizes waiting times at bus stops (Fan and Gurmu, 2015). Travel time is vital information for the whole transportation system. It reflects the performance of road networks and has direct meaning to many audiences, including engineers, planners, and other road users (Zaki et al., 2013). It is essential, as it attracts more passengers and increases passenger satisfaction, well-being, and reduces uncertainty (Amita et al., 2016; Zheng et al. 2015).

Travel time reliability and delay variability are key factors used by transportation engineers and travellers and are considered as very important tools for

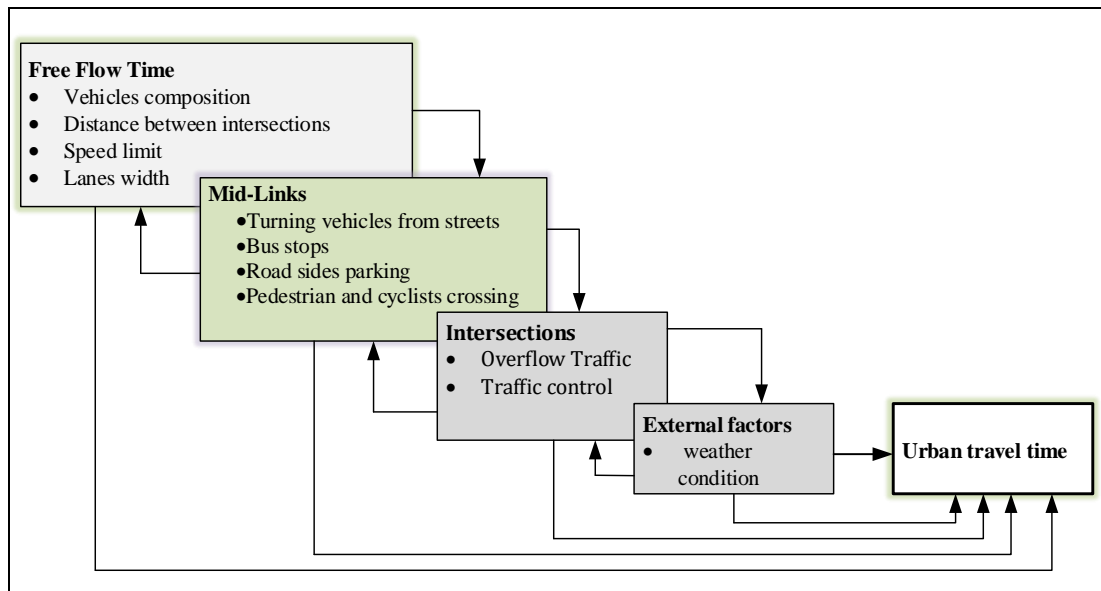
making decisions on the improvement of urban infrastructures, mode choice, the route to use, and departure time (Durán- and Tirachini, 2016). The uncertainty regarding travel time decreases the quality of service, which causes users to change their routes and schedules, even when the average travel time is concise (Li et al., 2016).

The provision of travel time variability will raise awareness of policy makers and transport planners, as it will enable them to integrate existing road networks and fleet operations to meet the needs of travellers and economic growth in urban areas (Durán and Tirachini, 2016). Travel time variability is an important indicator, which is applied when appraising transport infrastructure investment, as well as road pricing for urban road networks (Fosgerau and Fukuda, 2012). Travel time variation analyses, such as mean and standard deviation, are very important in both transport planning and operations. Predicting accurate travel time not only helps transport companies to route schedule and allocate resources more accurately, but also facilitates the development of more robust model choice and departure time models (Fosgerau and Fukuda, 2012). Furthermore, travel time variability reflects the degree of variation in route travel times for recurrent conditions over days, weeks, and years.

Vehicle travel time in urban areas consists of free-flow time, delay time (time lost due to congestion), and waiting time at intersections and bus stops. Delay time at intersections typically result from queues and traffic control, while free-flow time is influenced by mid-link delay time resulting from turning vehicles from cross streets, bus maneuvers at bus stops, parking vehicles along the roadside, crossing pedestrians, and cyclists (Chen et al., 2017).



Travel time variation on urban roadways is also influenced by the fluctuation of traffic demand, time of the day, day of the week, weather, seasonal effect, traffic information, and nature of road infrastructure, as presented in Figure 1.1. Moreover, external factors, such as weather conditions (e.g., rain, snow, flooding) and road incidents also influence travel time variation.



**Figure 1.1:** Factors Influencing Urban Travel Time Variability

Travel time prediction or estimation can be computed using either a direct or indirect approach (Zheng, 2011). The direct approach implies that the travel time is measured directly from the road sensors using loop detectors and probe vehicles with global positioning system (GPS) capability. However, installing loop detectors on urban roadways to collect traffic flow data is difficult for developing countries due to lack of funding to meet high costs associated with installation and maintenance (Shi et al., 2017; Fan and Gurmu, 2015). The indirect approach is a popular technique used to predict urban travel time by modelling factors influencing urban traffic flow.

Most travel time prediction models are developed under homogenous traffic conditions, with the assumption that travel speed was constant and has less impact on travel time prediction (Jammula et al., 2018). The behaviour of traffic flows in the developed countries is characterized by a strict lane discipline and single-lane motion of vehicles with restricted movement across the lanes (Anil et al., 2017). Kwon et al. (2000), Altinkaya and Zontul (2013), and Anil et al., (2017) developed urban travel time prediction models under homogeneous conditions using loop detector data. The results indicated that the models were reliable in terms of predicting urban travel time. However, the application of these models in developing countries where traffic flow is mixed with non-motorized and motorized transport (heterogeneous traffic conditions) may not provide reliable results.

Traffic flow in developing countries demonstrates a heterogeneous mix condition, due to different road facilities and vehicle composition which are influencing the uncertainty of traffic flow. The heterogeneous traffic flow condition occurred in the presence of a loose lane discipline and use of the entire road space without any quarantines for manoeuvring. The lateral movement of vehicles, apart from usual longitudinal motion, results mass queue formations that operate two-dimensionally. Furthermore, various compositions of vehicles have great impact in traffic flow speed, such as composition of non-motorized and motorized transport (Anil et al., 2017; Sen et al., 2011). This impact was caused by the existence aforementioned factors that vary over time and space.

Moreover, traffic light and traffic police are in charge of controlling traffic flow at the intersections simultaneously, which sometimes results in unpredictable delays. In

addition, there is no buses schedule associated with the bus stops, where buses can wait for passengers for a certain length of time, or bypass a bus stop (Vanajakshi, 2016; Zhang et al., 2016).

This research has developed a travel time model that incorporated link travel time, traffic flow, link distance, peak and off-peak hour, intersection delay time, and bus waiting time at the bus stops. Compared to the existing models, the use of intersection delay time and bus waiting time at the bus stops, in line with other parameters, improves the accuracy of travel time prediction, particularly for developing countries. The knowledge of urban travel time under heterogeneous traffic mix is essential for design, planning transport network and fleet operation in Dar es Salaam city.

## **1.2 Statement of the Problem**

The accuracy of travel time primarily depends on the prediction method and input data used. However, existing literature shows that travel time prediction models developed under the homogeneous traffic conditions are beneficial for monitoring urban congestion, especially in the majority of the developed countries (Arhin et al., 2016; Kumar et al., 2017). Limited studies have been performed on heterogeneous traffic conditions, and none of the existing models taking into account stochastic waiting at the bus stops and delays at the intersections. To address this knowledge gap, this research has developed a dynamic travel time model under heterogeneous traffic conditions, using delay time at the intersections and bus stops as input data, in developing countries, including Tanzania. Delay time at bus stops and intersections has been mentioned as among the significant factors that influence urban travel time

in urban road networks (Birr et al., 2014). The inclusion of delay time at intersections and bus stops will improve the accuracy of the travel time model, which reflects traffic flow conditions in cities of developing countries, including the City of Dar es Salaam. In this study, urban travel time prediction was divided into two stages. The first stage was to predict link travel time, and the second stage involved addressing the dynamic nature of link travel time. The Artificial Neural Network (ANN) was applied to model link travel time, and the dynamic Kalman Filter algorithm was used to predict future link travel time.

### **1.3 Research Objective**

The main objective of this research was to develop a dynamic travel-time prediction model for commercial bus (Daladala) travel time under heterogeneous traffic flow conditions, by applying a neural network with dynamic Kalman filter algorithm integration. A secondary objective was to determine travel time reliability and variations at intersections along the five main corridors of Dar es Salaam.

Three specific objectives were defined as:

- i. To develop the suitable urban travel time predicting model for bus that can incorporate heterogenous traffic flow conditions by applying an artificial neural network and dynamic Kalman Filter algorithm methods;
- ii. To establish travel time reliability for bus under heterogeneous traffic flow conditions; and

- iii. To determine delay time variation at intersections under heterogeneous traffic flow conditions.

#### **1.4 Research Significance**

The overall importance of this research is to provide general insights for evaluating and monitoring urban congestion, particularly under heterogeneous traffic flow conditions, to enhance transport plan knowledge and road user information. This research is relevant to several of the following practical applications:

- Travel time prediction models: instead of predicting the mean travel time or using Google route navigator, this study proposes a travel time prediction model which is more meaningful for urban networks that involve a number of uncertainties.
- Travel time reliability: the method of determining travel time reliability in this research provides the potential of assessing travel time reliability in urban areas, which is one issue outlined in the policy goals of Tanzania, particularly in the City of Dar es Salaam.
- The findings from this study are expected to be an ITS input to improve passenger knowledge for trip planning to minimize long travel time and waiting times at bus stops.
- Furthermore, it is expected that the findings from this research will be used by transport planners and engineers to evaluate transport service and the levels of service at intersections.

The output is expected to provide some insight, which will assist transport policy-makers with developing applicable policies that emphasize the improvement of capacity and quality of existing urban roadway infrastructure to accommodate increasing road traffic

### **1.5 Scientific Contribution**

The scientific contribution of this study is a state-of-the-art understanding of dynamic urban modelling in travel time prediction. The modelling and evaluation of urban travel time under heterogonous traffic flow conditions using an Artificial Neural Network and Kalman Filter dynamic algorithms is not explicitly addressed in previous studies. This study addresses this gap in knowledge for the first time, using the following approach (see Chapter 3):

- The dynamic travel time predictions model was derived under heterogeneous traffic flow conditions, which take into account off-peak, and peak hours, delay time at the intersections and waiting time at the bus stops on urban road networks;
- The analysis of travel time reliability provides more insights into how to evaluate urban travel time under heterogeneous flow conditions. Such analysis provides the foundation for traffic engineers and policy-makers to identify problems and determine the effectiveness of mitigation strategies;
- The delay time variation at the intersections was predicted, based on the Delay Time Distribution Model, to provide new knowledge on the evolution of delay time distributions at intersections under heterogeneous traffic flow conditions.

## 1.6 Organization of this Thesis

This thesis is presented in five chapters, whose contents are summarized below.

**Chapter one:** Briefly discusses background information, statement of the problem, objectives of the study, significance of the study, and research organization.

**Chapter Two:** This chapter discusses topics considered relevant and necessary to the modelling of urban travel time. First, theories of urban travel time are discussed, taking into consideration their technical part and their weaknesing in the application of urban travel time modelling. Secondly, the different techniques for establishing urban travel time reliability are discussed, taking into account the nature of traffic flow in developing countries, such as Tanzania. Finally, the concept of delay variation at urban intersections is discussed.

**Chapter Three:** This chapter covers a description of the research site and methodology. It also explains the philosophical underpinnings of travel time measures, data collection procedures, data sources, techniques, data collection tools, as well as data analysis. Furthermore, it describes the methodology designed to execute the research. Equations and Figures are presented to summarize the significant steps followed in the process of modelling urban travel time to determine travel time reliability and establish the delay variation at the intersections. A detailed description of methods and assumptions applied to model urban travel time is given.

**Chapter Four:** This chapter presents the research findings and a discussion of the results. First, the results from the specified objectives are discussed and evaluated based on the performance of the urban travel time model, in terms of Root Mean

Square Error (RMSE) and Mean Absolute Percentage Error (MAPE). Secondly, the results from route travel time reliability are discussed based on link length, waiting time at the intersections, and waiting time at the bus stops. Travel time reliability has been computed by applying standard deviation, coefficient of variation, buffer time, and planning time. Finally, the delay distribution results are discussed using the probability of vehicle delay at forty-one (41) Dar es Salaam intersections.

**Chapter Five:** This chapter presents the conclusions and recommendations resulting from the research. Each specific objective is treated with particular conclusions and recommendations to allow the reader to appreciate what was accomplished in each specific objective.



## CHAPTER 2-LITERATURE REVIEW

### 2.1 Introduction

Modelling travel time on the freeways (homogeneous traffic flow conditions) has been intensively discussed in the literature, including travel time prediction, travel time reliability, and delay time variations (Jammula et al., 2018; Čelan and Lep, 2017; Tian et al., 2015; Fan and Gurmu, 2015; Bharti et al., 2018; Torrisi et al., 2017; Bhourri et al., 2016; Chen et al., 2017; Hashim et al., 2017; Kiran et al., 2016). A number of these models showed relatively good results in predicting travel times on freeways. In this research, the focus is on the travel time prediction under heterogeneous traffic flow conditions on urban roads, which makes this study unique, due to of the added complexity of traffic processes at intersections and bus stops. The traffic characteristics of urban roads are significantly different from those of homogeneous traffic conditions.

Travel time consists of the following elements:

- i. Driving time, primarily calculated by travel distance and free-flow speed characteristics;
- ii. Waiting time at intersections, determined by the traffic control imposed at the intersections and waiting time at the bus stops, which is based on bus scheduling;
- iii. Time lost due to secondary operations, such as parking movements, loading and unloading vehicles and buses at stops, crossing pedestrians and cyclists, and turning vehicles from cross streets.

In heterogeneous traffic flow conditions, travel time is determined by the speed limit, vehicle composition, driving behaviour, lane width, the number of lanes, and spacing

between two intersections (Zheng et al., 2015; Mathew, 2014b). Mid-link delay time is mainly caused by the buses at bus stops, vehicles parking along the road, and pedestrians and cyclists crossing the road. Also, the delay time is caused by queue lengths, which are a result of urban road bottlenecks (Kumar et al., 2014).

Specifically, the research focused on developing a model based on free travel time in a link, waiting time at the bus stops, and delay time at the intersections, excluding intermediate non-motorized interruptions. Factors that influence travel time in the links, such as traffic volume and traffic states (off-peak and peak hours) were also incorporated. Moreover, delay at the intersection and dwell times at bus stops were also included in the developed model.

Specifically, the research focused on developing a model based on free travel time in a link, waiting time at the bus stops and delay time at the intersections excluding intermediate non-motorized interruptions. It incorporated some factors that influence travel time in the links such as traffic volume and traffic states which are off-peak and peak hours. Moreover, waiting time at the bus stops and delay at the intersection will also be included in the model developed.

## **2.2 Urban Travel Time Prediction**

Most researchers categorize travel time prediction models based on data sources and model approaches (Zhu et al., 2018). With the data sources method, travel time estimation and prediction are measured directly from fixed sensor-based (e.g., Bluetooth loop detectors, cameras, etc.), mobile sensor-based (e.g., probe vehicles equipped with GPS devices or mobile phones), and multiple data sources (e.g., combination of fixed sensor data and mobile sensor data) (Yusuf, 2013). A model approach uses the existing model and theories to estimate or predict travel time (Bai

et al., 2015). Furthermore, the model approach is classified into model-based methods and pure data-driven methods, which are common methods used to estimate and predict urban travel time (Zheng et al., 2015).

Model-based methods make use of traffic flow models to predict travel time along a route of interest. The models apply primary and secondary data to calibrate its parameters and to determine the coefficients. On the other hand, pure data-driven approaches use statistic data to establish the relationship, i.e., trend analogies between the independent and dependent variables (e.g., the relationship between traffic flows, traffic density, and speed).

### **2.2.1 Model-Based Methods**

The model-based method, including the Queue Theory Based Model, Traffic Flow Theory Model, Cumulative Vehicle Count Model, and Time-dependent Arterial Model, are discussed in this section

#### **2.2.1.1 Queue Theory Based Model**

Queuing Theory is the art of estimating or predicting the queue length and waiting times in the transport system. It uses queue lengths, traffic flow, link length, link capacity, and link speed as the parameters to predict urban travel time (Adan and Resing, 2010). The model is also known as the Sandglass Travel Time Model because of its character of discharging vehicles as sand particles flowing at the bottom of glass water. In this model travel time is computed as shown in Equation 2.2.1. The equation contains two parts: the first part is the waiting time during the queue time, and the second part is the running time in the uncongested link.

$$TT = \frac{N_q}{c} + \frac{L - L_q}{u_f} \quad 2.2.1$$

where,

$TT$  is the vehicle travel time,

$N_q$  and  $L_q$  are the number of vehicles in the queue and queue length respectively,

$L$  is the link length,

$c$  is the link capacity and,

$u_f$  is the free-flow speed.

The application of this model requires extensive data collection and calibration of the model parameter, such as load capacity, free flow, jam density, and queue length, which is complicated. Furthermore, it is very difficult to obtain such data in developing countries, such as Tanzania. This is due to the limited number of road facilities where data can be collected.

### **2.2.1.2 Traffic Flow Theory Model**

Traffic Flow Theory model is a useful tool for describing dynamic traffic flow that takes into account the conservation of vehicles. This model assumes no vehicles are created or lost, which means vehicles are conserved in the transport system (Lighthill and Whitham, 1955). Equation 2.2.2 implies that the traffic flow is conserved, which means there is no vehicle which is entering or exiting through the link during the evaluation period. In other words, it implies that the number of vehicles entering the

beginning of the road section is the same as the number of vehicles exiting at the end of the road section.

$$\partial q \frac{(x,t)}{\partial x} + \partial k \frac{(x,t)}{\partial t} = 0 \quad 2.2.2$$

$$q = F(k) \quad 2.2.3$$

where,

$q = q(x, t)$  and  $k = k(x, t)$  are the traffic volume and density at instant  $t$  and location  $x$ , respectively.

The combination of Equations 2.2.2 and 2.2.3 yield the following partial derivative in the traffic density, Equation 2.2.4. The dynamic traffic flow can be described in Equation 2.2.4, with the assumption that the traffic speed corresponds to the traffic flow.

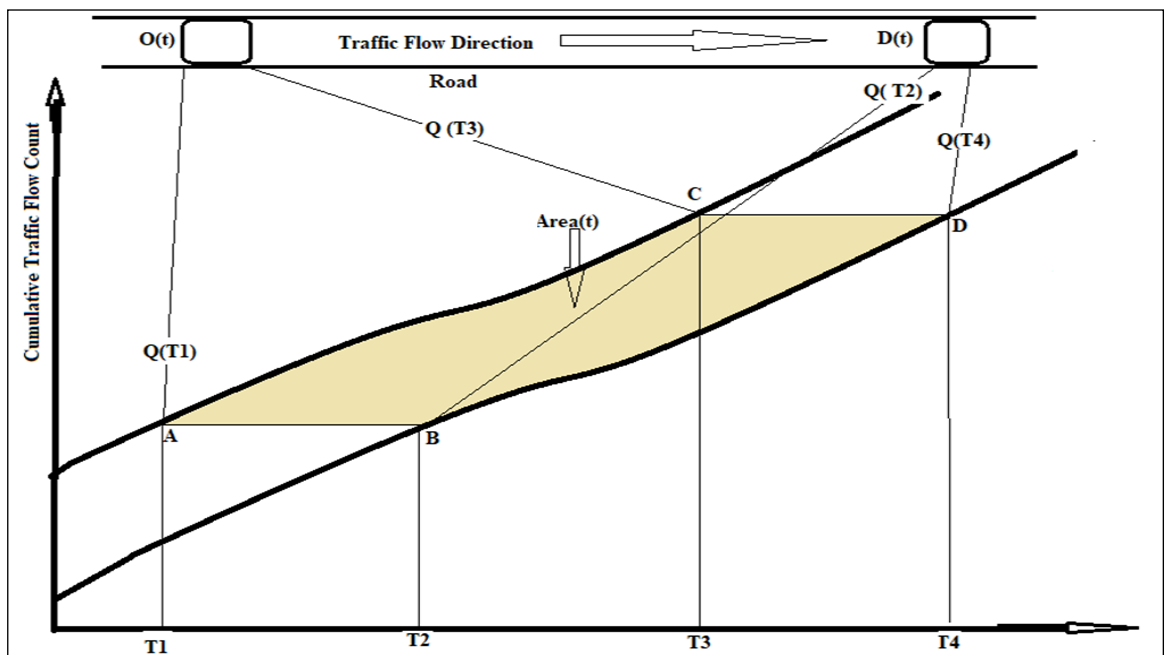
$$\frac{\partial k(x,t)}{\partial t} + \frac{dq}{dt} \frac{\partial k(x,t)}{\partial x} \quad 2.2.4$$

Equation 2.2.4 is also known as the principle of conversation of vehicles, and Equation 2.2.3 represents the so-called fundamental diagram traffic flow. This model is widely used in predicting dynamic travel time on highways, and results are promising, especially in developed countries where homogeneous traffic flow conditions exist (Zheng, 2011). However, if applied directly to heterogeneous traffic flow conditions, where traffic flow is mixed, with non-motorized and motorized transport, the model may not represent actual conditions. Furthermore, traffic flow in most cities in developing countries is characterized by frequent entrance and exit of

vehicles and interruptions by traffic police at intersections. The availability of data, such as traffic density and traffic volume, are very costly in terms of collection tools and legal authority that deals with traffic flow information.

### 2.2.1.3 Cumulative Vehicle Count Model

A Cumulative Vehicle Count model involves a traffic count model, applied using two loop detectors to calculate vehicle travel time between two points, and employing cumulative vehicle plots. Bhaskar et al., (2009) used these methods to estimate travel time from upstream and downstream locations in Lucerne, Switzerland. The results indicated that the model performs well in terms of travel time prediction, and is equivalent to real-time estimates from the number plate survey method. Travel time estimation is based on the starting time ( $t$ ) and the exiting time at the destination ( $t$ ), as indicated in Figure 2.1.



**Figure 2.1:** Traffic Flow Cumulative

Note: ( $T1$ ) is the traffic flow arrival curve at time  $T1$ , ( $T2$ ) is the cumulative curve at the exit at  $T2$ .

The travel time of vehicle  $N$  is calculated as indicated in Equation 2.2.5.

$$TT(N_{T_1}^{T_2}) = T_{T_2} + T_{T_1} \quad 2.2.5$$

where,

TT is the travel time,

N number of vehicles,

T1 and T2 are the entry and exit time.

Travel time is estimated based on a cumulative count of inflow traffic at the origin and outflow traffic at the destination. This approach is known as a cumulative count model. The numbers of vehicles are counted immediately upon entering a link at the moment the vehicles leave the link, as indicated in Figure 2.1. The cumulative traffic entry and exit at the origin and destination, respectively, are recorded by detectors. The model is very sensitive and depends on the accuracy of the detector count. If new vehicles enter, or park or a car overtakes or deviates from the link within the section, the result may not reflect the real link travel time, which is the weakness of this model (Bhaskar et al., 2009). Link travel time is defined as the difference between entry and exit times.

The deficiency of this model is miscounting the number of vehicles between origin and destination detectors. The model is very sensitive in vehicle flow sequence. Although, proper counting is done at the origin, when vehicles diverge or enter at the middle of the section, the last detector assumes that there is no addition of cars in between, which is a counting error. The application of a count model in

urban areas, where the traffic count is interrupted or mixed, may not provide accurate travel time estimation. This model may not be easily applicable in most cities in developing countries because road network detectors are lacking.

#### 2.2.1.4 Time-Dependent Arterial Model

Most travel time models are used to predict or estimate travel time by the summation of free flow time and stopping time, as in Equation 2.2.6.

$$TT = T_f + T_s \quad 2.2.6$$

where,

$TT$  is the link travel time;

$T_f$  is the free flow time; and

$T_s$  is the stopping time.

Liu *et al.*, (2006) improved the model by using high-resolution data from loop detectors that combine free-flow travel time, delay time in the queue, and delay time due to traffic control. The travel time of the arterial link is, therefore, calculated as indicated in the Equation. 2.2.7.

$$TT_{(t)}^{O-D} = \sum_{t=0}^n tt_f^{O-D} + \sum_{t=0}^{O-D} Q_t^{i-(i-1)} + \sum_{t=0}^{O-D} D_t^{i-(i-1)} \quad 2.2.7$$

where,

$TT^{O-D}_{(t)}$  is the predicted travel time from origin  $O$  to destination  $D$  at the departure time instant  $t$ ;



$TTf^{O-D}$  is the free-flow travel time from the upstream intersection  $i$  to the downstream intersection  $i+1$ ;

$Q_{(t)}^i$  is the queuing delay encountered by the vehicle arriving at the intersection  $i$  at time instant  $t$ ; and

$D_{(t)}^i$  is the signal delay encountered by the vehicle arriving at the intersection  $i$  at time instant  $t$ .

The results show excellent performance at the expense of the high cost of installing road sensors along surveyed areas. Road sensors can collect data, such second-to-second detector data and signal control data, and are typically unavailable in most developing countries.

The general application of the model-based method to predict urban travel time, especially in most developing countries, is impossible due to the nature of traffic flow (heterogeneous traffic flow conditions), unavailable traffic data, and insufficient urban road facilities for collecting traffic data.

### **2.2.2. Pure Data-Driven Methods**

Pure data-driven methods are pure statistic data collected, organized, and analysed to create or to establish relations, trends or similarities between two or more parameters, which are dependent and independent variables (e.g., speed, time, and distance) and to estimate or predict travel times without using the existing models. The models determine the logical structure of a database in such a way that data can be stored, organized, and manipulated. Data-driven models are commonly used to estimate or predict urban travel time by analysing the collected data from the road networks. Some previous studies classify a purely data-driven approach using several

different methods (Shalaby and Farhan, 2003; Jeong and Rilett, 2004; Abdalla and Abdel-Aty, 2006; Vanajakshi and Rilett, 2007; Jindal *et al.*, 2017; Kumar, Vanajakshi and Subramanian, 2018). These methods are discussed in the following subsections and evaluated for their ability to estimate and predict urban travel time.

### **2.2.2.1 Historical Data Models**

Historical data models basically apply historical data and are commonly used to predict car travel times or traffic flow using previous data. For the case of urban travel time estimation, these models are applied when the traffic flow is relatively small and stable, with the assumption that the current traffic condition is stationary (Amita *et al.*, 2015). Williams and Hoel (2003) argue that traffic flows normally depend on the time of day, day of the week, and travel time patterns. They further explain that historical models are suitable when analysing time and day of the week. Therefore, these models are reliable only when the traffic pattern in the area of interest is relatively stable, especially in rural areas.

Jeong and Rilett (2004) developed a travel time model for predicting bus arrival time by comparing three models: A Historical Data model, Regression model, and Artificial model. The results show that the Historical model did not perform well in terms of prediction accuracy compared to the other models. Lin and Zeng (1999) developed a Historical Data model for predicting rural travel time using four algorithms. The performance of the algorithms was evaluated in terms of accuracy, steadiness, and robustness, and the results indicated that the Historical Data model performs well compared to other models. However, in most cases, the Historical Data model performed better in rural areas than in urban areas because of the stability of traffic flow in the rural areas (Bacon *et al.*, 2011).

### **2.2.2.2 Time Series Models**

Time Series is a sequence of well-defined data points measured at consistent time intervals over a period of time. Time series models are popular in the prediction of travel time. Ta-Yin and Ho (2010) developed a Time Series model to predict urban travel time using historical speed data from a vehicle detector. One advantage of these models is that the traffic state (speed, flow, occupancy, etc.) or travel time in previous time intervals, can be incorporated to predict travel time in the next time interval, especially for trend prediction. However, this model is based on the previous traffic flow trend, without taking into account current traffic flow and missed data. As such, these models cannot capture current traffic flow behaviour or changes in traffic flow, such as from congestion to free-flow conditions. The accuracy of time series models highly relies on the similarity between the real-time and historical traffic patterns. Furthermore, these models require a large amount of historical data, which is generally not available in most developing countries.

### **2.2.2.3 Regression Models**

Regression models predict and explain a dependent variable, using the mathematical function formed by a set of independent variables (Kwon and Bickel, 2000). Unlike historical data-based prediction models, these models perform better, especially for a stable traffic flow state. Regression models usually measure the simultaneous effects of the variables, which are independent and are affecting the dependent variables. Hawas (2013) developed multi-linear regression models to estimate bus travel times using average traffic intensity, posted speed, route length, bus frequency, loadings,

and alighting time as independent variables. The results revealed that the models perform well in terms of bus travel-time prediction in urban road networks.

Wu et al., (2004) applied Support Vector Regression (SVR) to predict urban travel-time and compared the results to other baseline travel-time prediction methods using real highway traffic data. Hawas (2013) used micro-based regression to estimate bus route and network travel time, and the models were calibrated to predict both route and overall network travel times.

Jeong and Rilett (2004) developed and compared the historical data-based model, regression models, and Artificial Neural Network (ANN) models to predict bus arrival time. The results found that ANN models outperformed the historical data-based model and regression models, in terms of prediction accuracy. Wang et al. (2014) proposed a bus arrival-time prediction by applying a Multiple Linear Regression model to Neural Networks (NNs) using a Radial Basis Function (RBF) and adjusted online data, and compared the data with the RBFNN without online adjustment. The results revealed that RBFNN with online data adjustment had a better predicting performance. However, the models are simple and can incorporate more than one parameter, and the applicability of the multi-regression models in urban areas is limited because most of the variables in urban traffic flow are highly integrated (Chien et al., 2002).

#### **2.2.2.4 Artificial Neural Network Models (ANN)**

The Artificial Neural Network (ANN) is computer software that inspires the biological functions of neural cells in human brains, aiming at acquiring the

intelligent features of neural cells. NNs can learn by example. They can be trained to recognize a car image by showing it several times, or can predict future travel time by feeding historical travel time data. ANN models are capable of dealing with complex and noisy data and are suitable for finding nonlinear relationships between the dependent variable and independent variables. NNs have been widely applied for short-term traffic flow and travel time prediction, especially in urban areas (Fan and Gurmu 2015).

ANNs are gaining popularity in predicting bus arrival time because of their ability to solve complex non-linear relationships (Chien et al., 2002; Ghiassi et al., 2005; Altinkaya and Zontul, 2013; Gurmu et al., 2014; Amita et al., 2015; Jindal et al., 2017). In one study, Amita et al. (2015) predicted bus travel time by applying ANNs. The results reveal that the ANN model outperformed the Regression model, in terms of accuracy and robustness.

Fan and Gurmu (2015) developed three dynamic travel time prediction models: Historical Average (HA), Kalman Filtering (KF), and ANN. The accuracy and robustness of each model was compared to obtain a suitable model. Results indicated that the ANN outperformed the other two models in accuracy and robustness. ANNs have the ability to not only learn, but also model non-linear and complex relationships and are widely used to estimate and predict urban travel time. Several studies have used ANNs to predict urban buses travel time (Chien, et al., 2002; Jeong and Rilett, 2004; Ghiassi et al., 2005; Liu et al., 2006; Ta-Yin et al., 2010; Zheng and Van Zuylen, 2013; Gurmu et al., 2014). Zheng and Van Zuylen (2013) developed an ANN model and compared it with analytical models proposed

by Hellings et al., (2008), using data derived from a VISSIM simulation model. The results indicated that the ANN model outperform the analytical model.

Gurmu et al., (2014) developed a travel time prediction model by comparing the ANN and HA models based on two criteria: prediction accuracy and robustness. The results show that the ANN outperformed the HA model in both aspects. Wang *et al.* (2014) compared the Multiple Linear Regression model, NNs, and the RBFNN model using historical data, and later adjusted the models using online data. The results show that the RBFNN online data model had a better predicting performance than the other two models. Amita et al., (2015) employed the ANN to predict urban travel time, based on the model's accuracy and robustness, compared with other models, in predicting bus travel time.

Furthermore, Fan and Gurmu (2015) compared the HA, KF, and ANN models to obtain sufficient dynamic models using GPS data. The results revealed that the ANN models outperformed the other two models in both aspects. The ANN model performed well, in terms of predicting urban travel time, compared to all other pure data-based models. Zaki et al. (2013) presented an effective method to predict the expected bus arrival time at individual bus stops along a service route. The study combined a NN and KF to predict travel time, and the results were satisfactory and accurate.

#### **2.2.2.5 Limitation of Artificial Neural Network**

Artificial neural networks model is a popular model that used to perform nonlinear statistical data to provide solutions. These models are commonly used to predict or estimate urban traffic flow behaviour; however, it has a numbers of limitations such as low interpretability, poor scalability for handling large volume of

data and high cost for applying to all the lines of transport network. Furthermore, there is no specific rule for determining the structure of artificial neural network and appropriate network structure is achieved through experience and trial and error.

#### **2.2.2.6 Kalman Filtering Model (KF)**

The main advantage of Kalman Filter model is its ability to continuously change previous states, using tracking errors from the system, to update the current states. Furthermore, it can update the previous statistical data for the current states through an iteration process and minimize error to zero, compared with other mathematical models (Panomruttanarug and Longman, 2008). Kumar et al., (2014), applied KF to predict future travel time using the identified patterns from a temporal discretization model under heterogeneous traffic conditions. The results indicate that the proposed algorithm shows good improvement, in terms of accuracy prediction, compared to the space discretization model. Most of the literature suggests that these models can take into account the uncertainty properties of urban travel time in predicting future travel time, by adjusting the process and the measurement noise and minimizing the variance of the prediction error (Chen et al., 2004; Liu et al., 2006; Zaki et al., 2013; Vanajakshi, 2016; Shalaby and Farhan, 2003), as shown in Equations 2.2.7 and 2.2.8.

#### ***Kalman Filtering (KF) Equation***

There are two basic building blocks of a Kalman Filtering algorithm: the measurement equation, and the transition equation. In general, the measurement equation relates an unobserved variable  $x_t$  to an observable variable, as indicated in Equation 2.2.7.

$$Y_t = mx_t + \gamma_t \tag{2.2.7}$$

where,

$Y_t$  is the observable variable;

$x_t$  is the unobserved variable;

$m$  is the Kalman filter coefficient value that remains constant throughout time during travel time prediction; and

$\gamma_t$  is the measurement of noises, which has a mean of zero and a variance of  $\rho_t$ .

The transition equation in the KF algorithm is based on a model that allows the unobserved variable to change throughout time. In general, the transition equation is represented by Equation 2.2.8.

$$X_{t+1} = aX_t + \theta_t \quad 2.2.8$$

where,

$a$  is the transition equation coefficient value that remains constant through time; and

$\theta_t$  is the process disturbance noises, which have a mean of zero and a variance of  $q_t$ .

Several studies have applied a KF dynamic algorithm to predict urban travel time with very impressive results (Fan and Gurmu, 2015; Wang et al., 2014; Kormáksson et al., 2014). Moreover, other studies have showed that KF models are feasible and have a strong theoretical foundation in travel time prediction (Bai et al., 2015; Jiang et al., 2014; Altinkaya and Zontul, 2013). Compared to other statistic models, KF can iteratively incorporate previous travel time into current travel time to predict future link travel time.

### **2.2.3 Dynamic Travel Time**

Many transport planners, engineers, operators, and road users prefer knowing the future travel time of a particular route, rather than relying on estimated route travel



time. However, most of the models fail to predict future urban travel time because of the uncertainties and dynamics of traffic flow (Arnold et al., 2007; Vanajakshi et al., 2008; Bai et al., 2015; Anil et al., 2018). The interruption caused by travel conditions, such as traffic lights, traffic flow, daytime volumes, weather conditions, driving behaviors, and bus stops, make prediction of urban travel more complicated (Altinkaya and Zontul, 2013). The ability to obtain an accurate prediction model for real-time is vital. Chien and Kuchipudi (2003) developed a dynamic travel time prediction using real-time and historical data, with integration of the KF algorithm. Chen et al., (2004) developed a dynamic model for predicting bus arrival times at the bus stops, by applying an ANN model and using a KF dynamic algorithm to adjust the arrival-time to minimize prediction errors. The result indicated that KF algorithms have the ability of filtering noises present, due to short time arrival, and adjust them to the latest travel time. Zaki et al., (2013) developed a Dynamic Travel Time Prediction model for analyzing bus arrival time at individual bus stops along a service route by integrating ANN and KF. The results revealed that the model was reasonably capable of predicting arrival time at a bus stop.

Moreover, Chen et al., (2014) developed a dynamic algorithm using historical data to predict urban travel time. The results indicated that the proposed algorithm produced more accurate travel time than other models, in terms of mean absolute error. Elhenawy et al., (2014) proposed a dynamic travel time algorithm using historical model data to predict urban travel time. The results from this study showed that the model was not as useful as other models. Most of the literature indicate that the ANN can manage complex nonlinear spatial and temporal problems (Liu *et al.*, 2006; Jeong and Rilett, 2004; Amita et al., 2015; Jindal et al., 2017). However, a primary

problem with the ANN model is that it requires offline training with substantial input and output data. Nevertheless, most researchers conclude that the combination of the ANN model and other models, such as the KF algorithm, yield potential in predicting dynamic urban travel time (Altinkaya and Zontul, 2013; Zheng and Van Zuylen, 2013; Fan and Gurmu, 2015; Amita, Jain, and Garg, 2016).

#### **2.2.4 ANN and KF Dynamic Model**

A number of researchers have applied ANN models to predict urban traffic flow because of its ability to solve complex non-linear relationships (Amita et al., 2015; Bai et al., 2015; Fan and Gurmu, 2015; Chien et al., 2002). Zheng and Van Zuylen (2013) applied an ANN model to estimate urban link travel time using speed, position, and time-stamped information from probe vehicles as input data. Amita et al. (2015) employed an ANN to predict bus travel time, and the model outperformed in accuracy and robustness. Li et al., (2017) developed a travel time dynamic model by applying the ANN model to predict urban travel time using online data, and found considerable variation from the real travel time. However, it was argued that ANN models cannot capture noise errors and adjust predicted travel time continuously (Li et al., 2017; Bai et al., 2015; Fan and Gurmu, 2015).

The KF algorithm has been applied by different researchers in predicting the future travel time, whereby historical data were used as dependent variables (Chen et al., 2004; Fan and Gurmu 2015; Chien and Kuchipudi 2003). Overall results showed small variations, compared to real data, in terms of predicting real travel time, particularly during peak hours. Bai et al., (2015) developed a Dynamic Travel Time model by combining the ANN and the KF algorithm to predict bus travel time for multiple routes. Results from this study revealed that the model performed well

compared to other models used to predict multiple bus routes. Kumar et al., (2017) proposed a hybrid model that combined the Exponential Smoothing model and KF technique. The model showed significant improvement, compared with existing models, in the prediction of bus travel time. The KF algorithm is applied to adjust baseline travel time from the ANN to the future link travel time, because it can continuously update the state variable, based on the previous state, creating new observations (Zaki et al., 2013).

In summary, previous studies have managed to develop dynamic travel time prediction models based on homogeneous traffic, with the assumption of uninterrupted traffic flow. This is contrary to heterogeneous traffic flow conditions, where traffic flow comprises low and high-speed models of transport, interruption by traffic police at intersections, and unpredictable waiting times at bus stops. Also, most of the models use variables, such as trip distance, speed and traffic flow, as primary factors influencing urban travel time, without taking into account delay time at the intersections and waiting time at the bus stops. Recent studies indicate that the integration of the KF dynamic algorithm and ANN models outperform other models in terms of prediction accuracy. This study developed a Dynamic Travel Time Prediction model using delay time at intersections and bus waiting time at bus stops as one of the input parameters, and employed an ANN and KF algorithm, based on data collected in Dar es Salaam city.

### **2.3 Route Travel Time Reliability**

Travel time reliability is a key measure of congestion. It can serve as the starting point for prioritizing improvements in the urban transport system (Lyman, 2007). Passengers not only take travel time into account, but also travel time reliability

(TTR). Furthermore, Lyman and Bertini (2008) argue that travel time reliability in a given corridor has more importance to travellers, shippers, and transport managers than the travel time itself. However, the uncertainty of urban travel time decreases the quality of service and leads road users to change their routes and schedules, even when the average travel time is low (Bhourri et al., 2016). The movement of passengers in business and social activities becomes more complicated when travel time is not reliable. The diversity and geographical spread of these activities has resulted in a more intensive use of transport systems, and hence, greater dependence on the reliability of transport networks (Torrise et al., 2017).

For this reason, passenger prediction of hour of departure, destination, mode, and paths is not only affected by the average travel time experienced, but also by its variability through the perception of travel time reliability (Zhenliang et al., 2015). Also, it is noted that the unreliability of urban travel time can undermine the attractiveness of transport services and increase operation costs, due to loss of kilometers and lower fleet utilization (Taylor and Susilawati, 2012). Travelers may add more time to their average travel time for trips to limit the possibility of arriving late (Torrise et al., 2017). Several studies have argued that providing a reliable transport service, in terms of reliable travel time and good scheduling, is an obligation of public transport (Charlotte et al., 2017; Chen et al., 2009).

The factors affecting travel time reliability are unpredictable, such as demand flow, roadway geometrics, and other events, such as weather conditions and traffic incidents (OECD, 2010). Furthermore, uncertainty produced by fluctuations in traffic flow, traffic control, road incidents, road works, varying road geometry, rain, and snow makes travel time reliability unstable (Zhu et al., 2018). The effects of these

factors make prediction of travel time complicated and difficult to manage urban traffic flow. The composition of traffic flow in developing countries is mixed, with motorized and non-motorized motor vehicles using the same right-of-way. This mixture of fast-moving vehicles (e.g., passenger cars, buses, trucks, two-wheel motorcycles, and three-wheel motorcycles) and slow-moving vehicles (e.g., bicycles, tricycles, and pushcarts) adds to the difficulty in estimating travel time reliability (Anil et al., 2017). In most developing countries, travel time fluctuations are commonly influenced by a number of factors, as listed in Table 2.1.

**Table 2.1:** Factors Affecting Reliability

No	Factors	Description
1	Traffic condition	It includes traffic congestion, divergences and convergences of traffic, road incidents, such as accidents and working zone period.
2	Traffic composition	Mixture of traffic, such as motorized and non-motorized period (motor vehicles motorcycle, bicycles, pushcarts, tricycles, and pedestrians)
3	Delays at the intersection and bus stops	Police control at the intersections, signal delays, and waiting time at the bus stops period
4	Weather conditions	Rain and floods period
5	Other factors	Roadside parking and bumps; all these tend to reduce the vehicle speed period

**Source:** Field observation in Dar es Salaam 2019

One major drawback of using existing travel time reliability indicators is that most of the indicators are developed under homogeneous traffic flow conditions. Applying these indicators to heterogeneous traffic conditions may not represent reality (Torrise et al., 2017; Bhourri et al., 2016; Vanderval et al., 2014). A review of the

literature on travel time reliability reveals that studies on predicting travel time reliability under heterogeneous traffic conditions in developing countries are limited. Chen et al., (2009) analyzed travel time reliability at bus stops and routes in Beijing, China using three indicators: punctuation index, deviation index based on bus stops, and evenness index of bus stops. Mehran (2009) proposed a methodology for estimating travel time reliability using travel time variations as a function of demand, road capacity, weather conditions, and a buffer time index used to measure travel time reliability. The results revealed that the estimated travel time reliability could be applied in evaluating urban congestion in Japan.

In public transport, travel time reliability is considered as a quality of service measure, which enables passengers to choose the appropriate route, scheduling waiting time at bus stops, and mode of transport. Moreover, it enables operators to minimize frustrations in scheduling (Kieu et al., 2013). Travel time reliability is the indicator for evaluating the level of service (LOS) in given routes, and reflects the mobility and satisfaction of road users (Torrise et al., 2017). The importance of travel time reliability information has been viewed by users, transport engineers, transport planners, and road authorities as vital information for synchronizing daily activities, improving scheduling of fleet transport, and improving LOS (Mehran 2009). Taylor and Susilawati (2012) applied Buffer Index, Delft skewers, and fitted burr as a measure of travel time reliability, which opened the way for evaluating urban transport systems. Existing literature shows that travel time reliability is commonly measured using buffer time, tardy trip probabilistic measures, coefficient of variation, planning time, and misery index for urban areas (Bhourri et al., 2016;

Florida Department of Transportation (FDOT), 2016; U.S. Federal Highway Administration (FHWA), 2010; Chen et al., 2009).

### **2.3.1 Measure of Travel Time Reliability**

#### *Definitions of travel time reliability*

The United States (U.S.) Federal Highway Administration (FHWA) (2005) define travel time reliability as how much travel times vary over time. Travel time reliability is defined as the consistency or dependability in travel times, as measured from day-to-day and across different times of the day. Al-Deek and Emam (2006) and Vanderval et al., (2014) defined reliability as the probability that components, products, or systems will perform their intended functions satisfactorily for a specified length of time under the stated operating conditions. Moreover, travel time can be defined as how much travel time varies over the course of time (Gittens and Shalaby, 2015). Travel time reliability relates to how travel time, for a given trip and period, performs over time.

Vanderval et al., (2014) proposed different methods for measuring travel time reliability, such as standard deviation and coefficient of variation, which are used to quantify travel time reliability. Furthermore, average travel time has been used as a simple indicator for measuring travel time reliability (Bhourri et al., 2016). Margiotta et al. (2013) argued that standard deviation, the 90th percentile, and average travel are good indicators for measuring transport service quality. Standard deviation and the 90th percentile are the most widely used methods of evaluating transport systems worldwide (Russell, 2014). Different authors have measured travel time reliability as shown in Table 2.2.

**Table 2.2:** Travel Time Reliability Indicators

<b>TTR Indicators</b>	<b>Definition</b>	<b>Recommendation of measure</b>
Standard Deviation	Usual statistical definition	Margiotta et al., (2013)
Coefficient of Variation (COV)	The coefficient of variation shows the spread of the variability in travel time	Bhourri et al., (2016)
95th or other percentile travel time	This measures the delay occurring during the most massive traffic days on a particular route.	FHWA Guide (2006)
Buffer Index	This is a measure of the extra time a driver takes to complete the journey over the time taken for normal conditions. It is defined as the difference between the 95 <sup>th</sup> percentile travel time and the average travel time and then divided by the average travel time.	FHWA Guide. (2010) Bharti et al., (2018) Bhourri et al., (2016)
Planning Time index	This measures the total travel time (counting buffer time) and is calculated usually as the 95th percentile travel time over free- low travel time expressed as a ratio	This TTR measure is encouraged by various sources such as (FHWA 2010) Vanderval, et al., (2014)
Variation in Percent	This measures the ratio of the standard deviation to the mean, i.e., the coefficient of variation stated as a percentage.  It represents the association between the amount of variation and the average travel time in a percentage measure	Its use as a TTR measure is recommended by Bharti et al., (2018) and FHWA (2010)
Probabilistic Measure	It calculates the chance that Travel times occur within a	FHWA, (2010) and Bhourri et al., (2016)



TTR Indicators	Definition	Recommendation of measure
Misery Index (Adapted)	specified interval of time The average of the highest (5%) five per cent of travel times divided by the free flow travel time	(Bhourri et al., (2016)

Source: FHWA, (2010)

### 2.3.2 Standard Deviation

The standard deviation is a basic indicator used to reflect the reliability of transport service. It shows the variation of travel time, around the average, for a given time of the day. If the variation is very large, transport service becomes unreliable with extreme delays. This also makes the normal distribution curve to be widespread around the mean and vice versa (Guessous et al., 2014), as shown in Equation 2.3.1.

$$STD = \sqrt{\frac{1}{n-1} \sum_{i=1}^n (TT - M)^2} \quad 2.3.1$$

where,

*STD* is the standard deviation,

*n* is the number of travel time observations in a particular time of day or day of the week,

*TT* is the travel time observation on the day, at the time interval, and

*M* is the mean travel time.

### 2.3.3 Coefficient of Variation

The coefficient of variation is the ratio of the standard deviation to the mean travel time, as shown in Equation 2.3.2. It represents the variability of travel time.

$$CV = \frac{STD}{M} \quad 2.3.2$$

where,

*CV* is the coefficient of variation,

*STD* is the standard deviation, and

*M* is the mean travel time.

### 2.3.4 Percentile Value

The percentile value is a good approach for evaluating travel patterns in a given urban area, such as travel corridors in Dar-es-Salaam city, and 95th percentile indicators are very useful for evaluating transport services. The 95th Percentile travel time index, is the 95th percentile travel time divided by the free flow travel time. This is also known as the planning time index, and is the longest time that has been experienced by passengers, excluding average travel time as sufficient travel time to be used by a passenger to arrive on time. However, as long as this indicator does not include average travel time or delay time, it may not be applied directly to compute travel time reliability

### 2.3.5 Buffer time

Buffer time is the extra time users add to average travel time to ensure they arrived on time. It explains the extra percentage of time passengers will add to average travel time, due to travel time variability, in order to gain a higher probability of arriving on time (Bhourri et al., 2016). Buffer time is computed as shown in Equation 2.3.3

$$Bt = tt_{95} - tt_{50} \quad 2.3.3$$

where,

$Bt$  is the additional time above the average travel time ( $tt_{50}$ ),

$tt_{95}$  is the 95th percentile travel time, and

$tt_{50}$  is the average travel time.

### 2.3.6 Buffer Index (BI)

Indicators associated with this phenomenon are buffer time, Buffer Index (BI), and Planning Time Index (PTI) (Organization for Economic Co-operation and Development (OECD), 2010).

In practice, the buffer time varies from one user to another because every individual needs a different amount of extra time to arrive at his/her destination on time. For example, a BI of 40% means that a traveller should budget an additional 8-minutes of time to buffer a 20-minute average peak travel time to ensure on-time arrival (OECD, 2010). Buffer time index is computed as the difference between the 95th percentile travel time ( $tt_{95}$ ) and the average travel time ( $tt_{50}$ ), normalized by the average travel time ( $tt_{50}$ ). The BI is the ratio between the buffer time index and the average travel time as shown in Equation 2.3.4

$$BI = \frac{tt_{95} - tt_{50}}{tt_{50}} \quad 2.3.4$$

where,

$Bt$  is the buffer Index ( $tt_{50}$ ),

$tt_{95}$  is the 95th percentile travel time, and

$tt_{50}$  is the average travel time.

Equation 2.3.4 answers simple questions such as "How much time do I allow for the uncertainty of travel conditions?" or "When should I leave?" (Bhourri et al., 2016). The BI gives the percentage of time wasted for counterbalancing uncertainty, independently from the duration of the trip.

### **2.3.7 Planning Time Index (PTI)**

Planning time (PT) is the extra time passengers add in free time to arrive at their destination on time. PT is computed as the 95th percentile of the longest travel time that passengers experience, while buffer time is computed from the average travel. For example, a planning time index (PTI) of 1.60 means a passenger will allow an additional 60% of free-flow time to ensure on-time arrival. This is the total time a passenger needs to arrive at a destination with a 95% assurance of being on-time. PTI is computed as the 95th percentile travel time ( $tt_{95}$ ) divided by free-flow travel time ( $tt_{free-flow}$ ), as shown in Equation 2.3.5.

$$PTI = \frac{tt_{95}}{tt_f} \quad 2.3.5$$

The BI and PTI indicators use the 95-percentile value of the travel time distribution as a reference of the definitions, and take into account more explicitly the extreme travel time delays, compared to standard deviation indicators. Moreover, the BI and PTI indicators consider the complete pattern of the travel time distribution. Therefore, these indicators were deemed suitable for evaluating travel time reliability in this research.

### 2.3.8 Tardy Trip Measures

Tardy trip measures indicate unreliability impacts using the amount of late trip times. If travellers only use the average trip time for their travel plans, they will be late for half of their destinations and early for the other half (in round numbers). A misery index (MI) calculates the relative distance between mean travel time of the 20% most unlucky travellers and the mean travel time of all travellers, as shown in Equation 2.3.6.

$$MI = \frac{M_{tt} - M_{tt50}}{M} \quad 2.3.6$$

where,

$M_{tt50}$  is the Average travel rates for all trips,

$M_{tt}$  is the Average of the travel rates for the longest 20% of the trips, and

$M$  is the Average Travel Rate.

### 2.3.9 Probabilistic Measures

Probabilistic indicators (*Pr*) calculate the probability that travel times occur within a specified interval of time. Probabilistic measures are applied in the sense that travellers use a threshold travel time or a predefined time window to differentiate between reliable and unreliable travel times (Van Lint et al., 2008). The threshold assumes that travel times do not deviate more than  $\beta$  minutes from the median travel time, as indicated in Equation 2.3.7.

$$\Pr (tt \geq \beta + tt_{50}) \geq 95\% \quad 2.3.7$$

Where,

$\beta$  is given any value in minutes; and

it is the time users indicate that they have to add to their average travel time or to their free-flow time to avoid being late to their destinations.

The application of probability measures, standard deviation, and coefficient of variation may not be relevant indicators to travellers. Still, they are useful for operators and transport planners in evaluating the transport system. Also, these indices, i.e., *BI*, *PTI*, *MI*, are ratios, and therefore, unit less. Thus, they are comparable, regardless of the trip travel time, and are useful to fleet operators for the purpose of updating the scheduling.

Therefore, travel time reliability is a popular indicator, which highlights to travellers the extra time they should add to the average travel time to reach their destination on time. Also, it is very applicable to aspects of the transport industry such as ITS investment, road renewal, dedicated lanes, and how much should be invested to reduce travel time variability at a specified target (Charlotte et al., 2017). However, travel time in most developing countries operates under heterogeneous traffic flow conditions with mixed traffic flow.

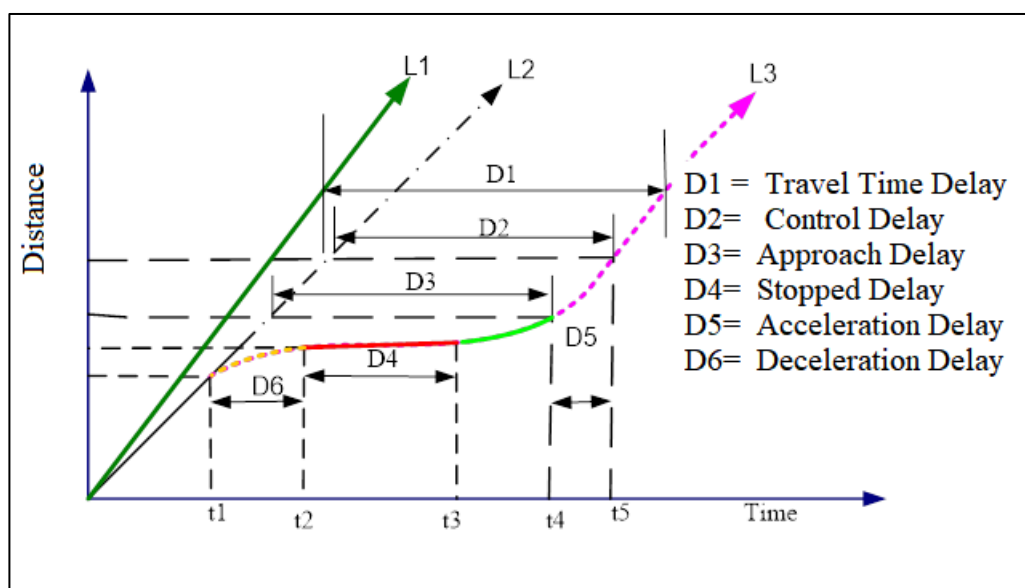
Motorized vehicles include two-wheelers, three-wheelers, passenger cars and vans, light commercial vehicles, buses, and trucks, and non-motorized vehicles include bicycles, tricycles, and pushcarts, many of which share the same road space. The determination of travel time reliability needs special attention, due to its complexity of traffic interruption, compared to homogenous traffic conditions. Moreover, few studies were conducted to analyze travel time reliability in developing countries, particularly Tanzania. This research determined travel time reliability based on link travel time, waiting time at bus stops, and delay at intersections on five main corridors in Dar es Salaam city, by applying buffer time,

planning time, standard deviation, and coefficients of variation to evaluate the travel time reliability along the five corridors.

## 2. 4. Delay Time Variation at the Intersection

### 2.4.1. Background of Delay Time

Delay time at intersections is the time lost by a vehicle or driver because of the operation of the signal and uncertainty of traffic flow (FHWA, 2005). The Transportation Research Board (TRB) (2000) defined delay time as the difference between the travel time experienced, with reference to the travel time that would result during ideal conditions, in the absence of traffic congestion, incidents, and any other vehicle obstacles on the road. Furthermore, delay at signalized intersections is the time spent by the vehicles due to signal control and queue length, as shown in the Figure 2.2 (Hashim et al., 2017)



**Figure 2.2:** Delay Types at a Signalized Intersection (Mathew, 2014; TRB, 2000)  
L1 is the free-flow path,

L2 is the desired path,

L3 is the actual path.

Delay at the intersections mostly depends on traffic conditions and time difference of the day. The desired path of the vehicle shows the actual progress of the vehicle, which includes a stop at a red signal, as in Figure 2.2. The desired path is the path when vehicles travel at their preferred speed, and the actual path is the path accounting for decreased speed, stops, and acceleration and deceleration. Mathew (2014) and TRB (2000) explained that when vehicles approach an intersection, they experience different types of delays, such as stopped-time delay and approach time delay, as indicated in Figure 2.2.

#### **2.4.1.1 Control Delay**

A control device, such as a traffic signal or stop sign, causes control delay. It is approximately equal to time-in-queue delay plus the acceleration-deceleration delay component. Delay time can be analyzed based on a single vehicle, as an average for all vehicles over a specified time or as an aggregate total value for all vehicles over a specified time. Aggregate delay is measured in total vehicle seconds, vehicle-minutes, or vehicle-hours for all vehicles that passed during a specified time interval. The individual vehicle average delay is generally stated in terms of seconds per vehicle for a specified time interval, as illustrated in Figure 2.2.

#### **2.4.1.2 Approach Delay**

Approach delay includes stopped-time delay, but adds the time lost due to deceleration from the approach speed to a stop and the time lost due to re-



acceleration back to the desired speed, as indicated in Figure 2.2. It is found by extending the velocity slope of the approaching vehicle as if no signal existed. Approach delay is the horizontal time difference between the hypothetical extension of the approaching velocity slope and the departure slope after full acceleration is achieved. The average approach delay is the average for all vehicles during a specified time.

#### **2.4.1.3 Stopped-Time Delay**

Stopped-time delay is the time the vehicle is stopped in the queue while waiting to pass through an intersection. It begins when the vehicle is entirely stopped and ends when the vehicle starts to accelerate, as indicated in Figure 2.2. Average stopped-time delay is the average for all vehicles during a specified time.

#### **2.4.1.4 Running Time Delay**

Running time delay is the total time of a vehicle joining an intersection in the presence of a queue to discharge across the stop line on departure. Average time in queue delay is the average for all vehicles during a specified time. Time-in-queue delay cannot be effectively shown using one vehicle, since it requires long observations of several vehicles in the queue crossing the intersection.

### **2.4 2 Theory of Delay Variability**

Population and economic growth have resulted in a higher demand for travel, thus, causing mobility challenges in terms of limited capacity on existing urban road networks, as well as delay variation at intersections (Li et al., 2016). Understanding the vehicle delay variability at intersections is very important for the planning,

design, and analysis of signal controls (Fu et al., 2000). The estimation of delay variation at intersections provides a comprehensive understanding of urban travel time variability. It improves the prediction or estimation of urban travel time more accurately (Mathew, 2014a). Charlotte et al., (2017) and Torrisi et al., (2017) argued that passengers are not only interested in knowing urban travel times, but also the variability of travel times.

Understanding variability is very important to passengers for better organization of their daily and non-daily activities, and to synchronize their schedules with other people. Accordingly, the accurate prediction of delay variation at intersections is very important. However, its precise estimation is difficult due to random traffic flow and other uncontrolled factors. Uncertainties of traffic flow and queue length at intersections are the significant factors affecting urban travel time variability (Hashim et al., 2017). Furthermore, estimating delay variability at intersections has been extensively studied, and several methods have been widely used at signalized intersections (Olszewski, 1993; Fu and Hellenga, 2000; Chen et al., 2017). Webster (1958) demonstrated average delay variability cycle to cycle at signalized intersections with homogeneous traffic flow, based on one-lane traffic flow, as shown in Equation 2.4.1.

$$d = \frac{c(1-\alpha)^2}{2(1-\alpha x)^2} + \frac{x^2}{2(1-x)} \quad 2.4.1$$

where,

$d$  is the average delay time of a vehicle per cycle;

$a$  is the proration of cycle length, which is the effective green time; and

$x$  is the degree of saturation

The first part of the Equation 2.4.1 estimates delay time when traffic flow is considered to be constant, while the second part estimates delay time when traffic flow is considered to be random in the lane. The application of these models to non-lane in heterogeneous traffic conditions will result in the wrong estimation of delay time. Olszewski (1993) investigated delay distribution at signalized intersections by considering the number of vehicles arriving, the waiting time, and the discharging vehicles at the intersection. The model performed well, but the arrival distributions may not correspond to heterogeneous traffic conditions, which are common in developing countries.

### **2.4.3 Measure of Delay Variation at the Intersections**

Most cities in developing countries are undergoing fast urbanization, which results in increased road traffic. In these cities, traffic, including non-motorized and motorized modes of transport, is flowing in the same lane causing a lot of chaos on the urban roadways (Anil et al., 2017). The prediction of travel time in urban networks becomes more complicated because of travel time variability (Jammula et al., 2018), and the major component of urban travel time variations occur at the intersections. Zheng and Van Zuylen (2011) analyzed delay time in the urban road networks and determined that about 50% of delay time variations were found at the intersections.

Most cities in developing countries, including Dar es Salaam in Tanzania, have mixed traffic, and vehicles can shift laterally from one lane to another, which causes physical and travel time variations in urban road networks (Preethi et al.,

2016). There is no lane restriction adherence during the traffic flow. Moreover, it is observed that lack of lane discipline at intersections causes notable lateral movements, and vehicles tend to use lateral gaps to move to the front of the queue. Also, in most cities of developing countries, like Tanzania, traffic police are used to control traffic flow. Traffic flows towards the city centre are given more priority at intersections during morning peak hours, and vice versa (during the evening). This practice causes excessive delay variations at the intersections. Under these conditions, estimating delay variations at the intersections using existing delay models, such as those used by Webster (1958), Olszewski (1993), and the TRB (2000), developed under homogeneous traffic conditions, will not produce realistic estimates if directly applied to heterogeneous traffic conditions. The parameters of delay variation mainly depend on the non-deterministic nature of the arrival, departure processes, and heterogeneous traffic conditions at the intersection. These variables cause more uncertainties and chaos that make prediction of delay time at intersections more complicated (Hashim et al., 2017).

Darma (2005) argues that cycle time, inter-green time, number of phasing sequences, and number of lanes are the major variables that influence delay variation at signalized intersections, with the assumption that traffic flow is constant. Moreover, the stop delay time related to the red phase duration and saturation level have been mentioned to be the main factors influencing delay variation at intersections (Chen et al., 2013; Cheng, 2015). This is consistent with Webster's (1958) delay model that estimates delay variation based on deterministic queuing analysis and under-saturated traffic flow with homogeneous traffic conditions at intersections.

Understanding the vehicle delay variability at intersections provides very important information for evaluating signal controls and settings (Fu et al., 2000). It has been recognized that the estimate of the delay variability is important in many aspects; for example, the delay variability information is applied to estimate the confidence limits of mean delay. This provides reliable information regarding signal planning by identifying optimal signal settings (Liping Fu and Hellinga, 2006). The estimation of delay variability also helps to identify future improvements for signal control and LOS at intersections (Li et al., 2016). Providing accurate travel time information to road users potentially helps them lessen their travel time, thus, helping to reduce urban congestion and yield more stable traffic flows (Zheng and Van Zuylen, 2010).

Charlotte et al., (2017) and Torrisi et al., (2017) argued that passengers are not only interested in knowing urban travel times, but also the variability of travel times. The understanding of travel time variability enables passengers to better organize daily and non-daily activities to match with their daily travel conditions. Delay time variations are applied to determine the performance of a signalized intersection, i.e., the LOS (Chen et al., 2016). Traditionally, the delay time variability at intersections has been measured mostly on freeways, where traffic flow is typically dominated by motor vehicles moving in clearly defined lanes (Hadiuzzaman et al., 2009); Zheng and Van Zuylen, 2010; Anil et al., 2017).

Preethi et al., (2016) argue that an accurate and reliable model is the one which clearly shows the delay time variation distribution at the intersection. Olszewski (1993) developed the Delay Variation Distribution model at signalized intersections under homogenous traffic flow conditions. Chen et al., (2016) applied

the delay variability model to estimate delay variability at signalized intersections for urban arterial performance. Although the model was able to show delay distribution at the intersections, it may not be applicable for intersections in cities of developing countries, where traffic flow is mixed. In developing countries, delays that individual vehicles experience at a signalized intersection are usually subject to large variations, due to the randomness of traffic arrivals, interruption caused by traffic signal control, and interruption of non-motorised transport (Miller, 1963).

There is no analytical method available to quantify delay time variation in the heterogeneous traffic conditions at signalized intersections, especially in developing countries. To address this gap in knowledge, there is a need for developing a Delay Variation model that will take into account heterogeneous traffic conditions. The evaluation of delay time variability, with respect to heterogeneous traffic conditions with interrupted flow, is the main focus of this study.

#### **2.4.4 Delay Time Variations Analysis**

Viti and Van Zuylen (2010) explained that the stochastic delays at signalized intersections constitute a large part of total travel time on urban road networks. Thus, understanding the delay evolution or delay variability will lead to further insights into the variability of urban road travel time and provide additional possibilities for travel time estimation. Fu and Hellinga (2000) argued that delays individual vehicles experience at a signalized intersection are usually subjected to considerable variation because of the randomness of traffic arrivals and interruption caused by traffic signal controls. According to Miller (1963), Newell (1965), Akçelik (1988), and Olszewski (1993), delay time variation at signalized intersections can be analyzed based on

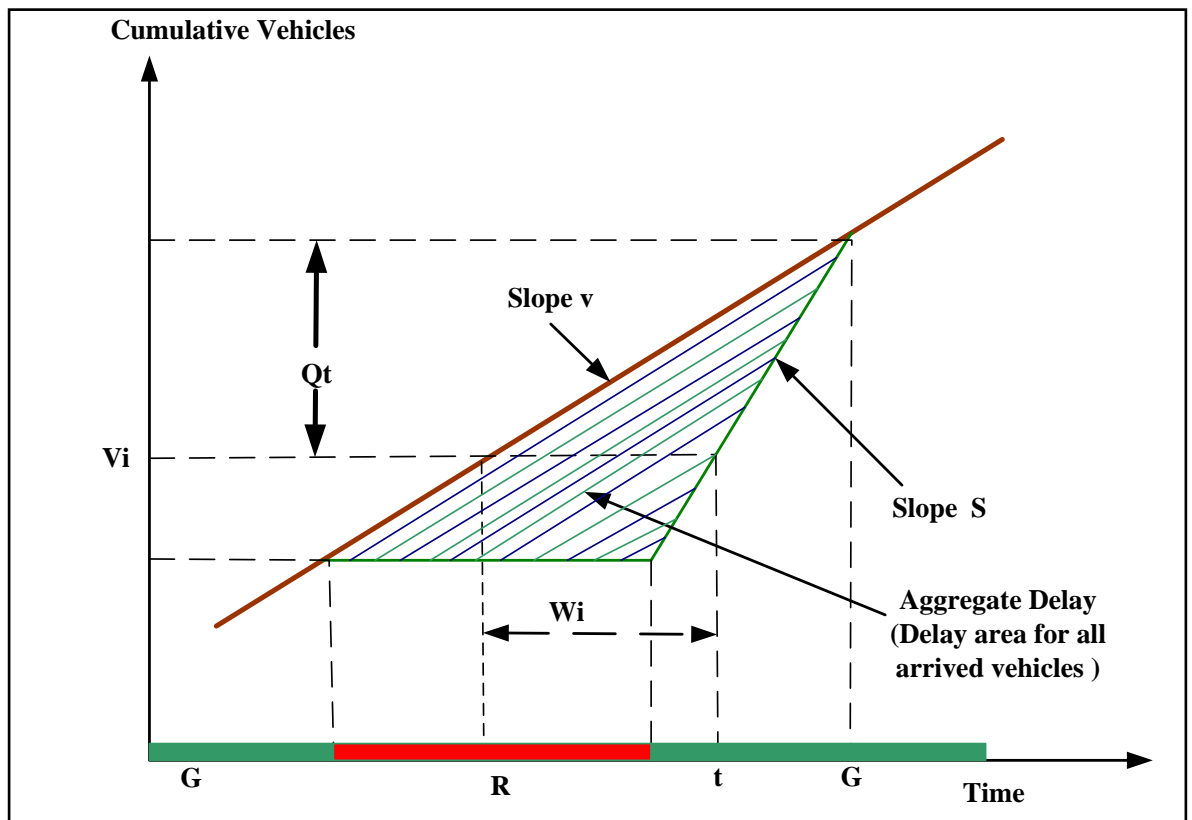
three traffic flow conditions: uniform delay, random delay, and overflow delay, as indicated in Figures 2.3, 2.4, and 2.5, respectively.

#### **2.4.4.1 Deterministic Queuing Model**

Fu and Hellinga (2006) evaluated delay time variation at intersections using the Standard Deviation model for two traffic flow patterns: highly under-saturated conditions and oversaturated conditions. The result indicated there was a high variation in delay time during oversaturated conditions. Analysis of delay time begins with the accumulation of vehicles arriving (V) and departing time (s) at a given signal location, as indicated in Figure 2.3. It shows a total number of vehicles arriving and departing at the signalized intersections. Two curves show arriving vehicles and departing vehicles. The time axis is divided into periods of effective green and effective red, and vehicles are assumed to arrive at a uniform rate of flow ( $v$  is the vehicles per unit time). The arrival curve represents a constant slope, with the assumption that the flow rate between vehicles is constant.

No previous queue is assumed, and arriving vehicles depart instantaneously when the signal is green (i.e., the departure curve is the same as the arrival curve). During the red phase, vehicles begin to queue and non-vehicles discharge. Thus, the departure curve is parallel to the x-axis during the red interval. At the effective green, vehicles in the queue begin to decrease linearly until the second red phase, at a constant flow rate called saturation flow rate (vehicles per unit time). For stable operations, the arriving vehicles catch up with the arrival curve before the next red interval begins (i.e., there is no residual queue left at the end of the effective green), as illustrated in Figure 2.3.

Figure 2.3 represents the total time that any vehicle ( $V_i$ ) spends waiting in the queue ( $W_i$ ), given by the horizontal time scale difference between the time of arrival and the time of departure. The total number of vehicles queued at any time ( $Q_t$ ) is the vertical vehicle scale difference between the number of vehicles that have arrived and the number of vehicles that have departed. The aggregate delay for all vehicles passing through the signal is the area between the arrival and departure curve, which is the total number of vehicles arriving during the study period divided by vehicle flow rate.



**Figure 2.3:** Uniform Delay Time at the Intersection (Mathew, 2014)

NB:

$V_i$  is the accumulation of vehicles at the intersection;



$W_i$  is the waiting time for a vehicle arriving during the red signal plus the departure time during the green time per cycle; and

$Q_t$  is the total number of vehicles queued at any time.

#### 2.4.4.2 Calculation of Uniform Delay Model

Uniform delay is determined with the assumption that the follow rate and departure rate of all vehicles was uniform at the intersection, as indicated in Figure 2.3. The total delay at each cycle was calculated as the triangular area between the cumulative arrival and departure curves (TRB, 2000). The vehicle average delay per cycle is shown by Equation 2.4.2.

$$Ud = \frac{C \left(1 - \frac{g}{c}\right)^2}{2 \left(1 - \frac{v}{s}\right)} \quad 2.4.2$$

where,

$Ud$  is the average delay per vehicle per cycle;

$C$  is the cycle time;

$g$  is the green time;

$v$  is the flow rate (arrival rate in vehicles per unit hour or second); and

$s$  is the departure rate (saturated rate, vehicles per unit hour).

The uniform delay model ignores the randomness in arrival and considers only unsaturated conditions, thus, it overlooks the oversaturated flow conditions. The second assumption is that vehicle acceleration and deceleration delays are converted into equivalent stopped delay time at the intersection. Furthermore, vehicle queues are assumed to be vertical at the intersection line stop, and do not represent the real

behaviour of queue traffic flow (Gupta 2009). However, in reality, the model may work during off-peak hours, with the assumption that the traffic flow is stable. For the case of Dar es Salaam, where traffic flow at intersections is interrupted by non-motorized vehicles and traffic police, it may not be applicable. Olszewski (1993) argues that an accurate estimation of vehicle delay is difficult because of the interruption of traffic flow at an intersection. Existing delay models simplify real traffic conditions and provide only approximate point estimates of average delay. In general, the uniform delay model assumes that arrivals are uniform and that no signal phases fail (i.e., that arrival flow is less than intersection capacity during every signal cycle of the analysis period).

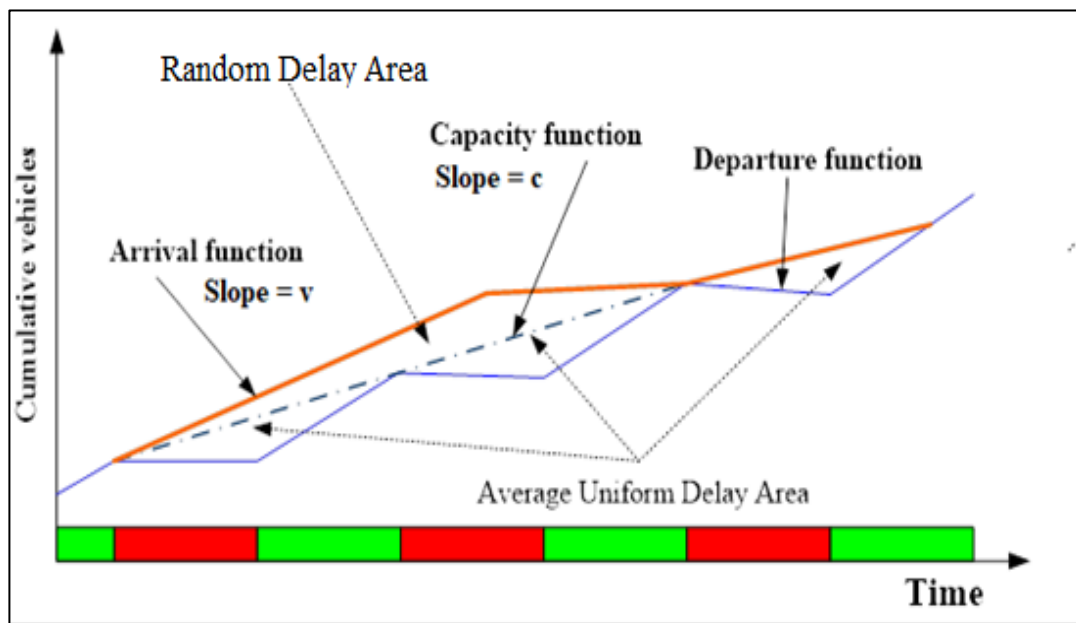
#### **2.4.4.3 Random Delay**

Random delay is additional delay, it can be higher or less than the uniform delay at a particular intersection, because traffic flows are randomly distributed rather than uniform flows. Some of the signal phases fail, as indicated in Figure 2.4. Vehicles fail to pass the first cycle during the green phase due to an abrupt increase of traffic flow, which exceeds intersection capacity. Therefore, they must wait for the next green phase interval to depart (Olszewski, 1993).

For this study, it was assumed that no queue remained unserved during the entire study period, rather, it is explained in the departure function. This case represents a situation in which the overall period of analysis is assumed to be stable (i.e., total demand does not exceed total capacity). For these periods, there is a second portion of the delay in addition to uniform delay. This portion of delay consists of the area between the arrival function and the dashed line, which represents the capacity of the intersection to discharge vehicles and has a slope  $c$  as

indicated in Figure 2.4. This type of delay is referred to as a random delay in isolated intersections. Vehicle arrivals are more likely to be random.

Many stochastic models have been developed for this case, including studies by Webster (1958), Miller (1963), Newell (1965), Akçelik (1988, 1993), Hall (1992), and Olszewski (1993).



**Figure 2.4:** Delay Time in Random Traffic at the Intersections (Mathew, 2014)

#### 2.4.4.4 Random Delay Model

The number of vehicle arrivals in a given time interval flow can be represented by a well-known distribution, known as a Poisson distribution, and it does not change over time. The headways between departure times at the stop line flow are a known distribution, with a constant mean. Furthermore, it is well known that temporary oversaturation may occur due to the randomness of arrivals, but it is assumed that the

system remains unsaturated over the analysis period. Finally, it is assumed that the system will remain unchanged for long enough during the running time  $k$ .

Random delay models generally assume that vehicle arrivals follow a Poisson distributed model, with an underlying average rate of vehicles per unit time (Cheng et al., 2015). The models account for random arrivals, as well as the fact that some individual cycles within a difficult period with a  $v/c < 1.0$  could fail due to this randomness. This is explained by the formula presented by Webster (1958), as shown in Equation 2.4.3.

$$RD = \frac{X^2}{2v(1-x)} \quad 2.4.3$$

where,

RD is the average random delay per vehicle (s/veh),

X is the degree of saturation (v/c ratio), and

V is the intersection flow rate.

Webster (1958) modified the above delay formula, whereby the total delay is given by the sum of uniform delay and random delay multiplied by a constant, as shown in Equations 2.4.4a and 2.4.4b.

$$D = 0.9(UD + RD) \quad 2.4.4 \text{ a}$$

$$D = 0.9 \left( \frac{C \left(1 - \frac{g}{C}\right)^2}{2 \left(1 - \frac{v}{C}\right)} + \frac{x^2}{2(1-x)} \right) \quad 2.4.4 \text{ b}$$

where,

RD is the average random delay per vehicle (s/veh),

X is the degree of saturation ( $v/c$  ratio),

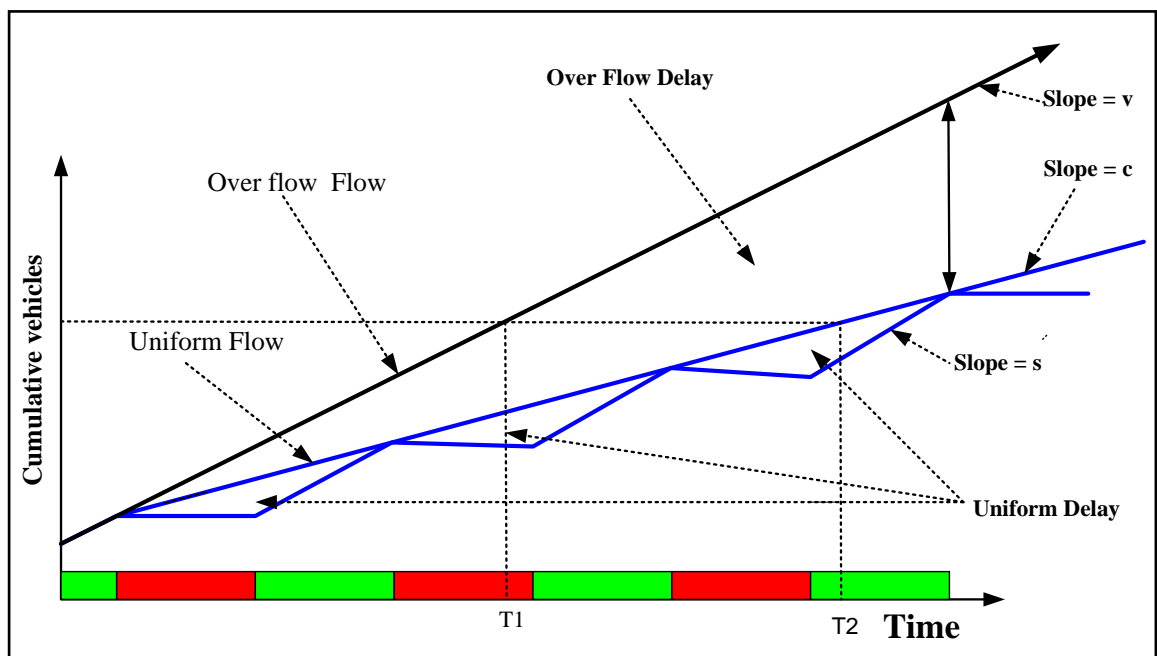
V is the intersection capacity,

C is the cycle time, and

g is the green time.

#### 2.4.4.5 Overflow Delay

Overflow delay is the additional delay that occurs when the capacity of an individual phase or series of phases is less than the demand or arrival flow rate. The discharge rate during the green interval fails for a significant time, and the residual, or unsaved queue of vehicles, continues to grow throughout the analysis period, as indicated in Figure 2.5.



**Figure 2.5:** Delay Time over Traffic Flow (Mathew, 2014)

T1 is the arrival time of the vehicle,

T2 is the departure time of the vehicle, and

The difference between T1 and T2 is the period of analysis.

In this case therefore, the overflow delay component grows over time, and at the same time, dropped consistently in each cycle by the uniform delay component. When demand exceeds capacity ( $v/c > 1.0$ ), the delay depends upon the length of time that the condition exists. During the period of oversaturation, the average delay per individual vehicle consists of both uniform delay and overflow delay, as indicated by delay model presented by Webster (1958), and shown in Equation 2.4.5.

$$OD = \frac{T}{2} \left( \frac{v}{c} - 1 \right) \quad 2.4.5$$

where,

OD is the average overflow delay,

T is the analysis period time,

V is the arrival flow rate, and

C is the road capacity.

The accurate estimation of delay is difficult because of the randomness of the traffic flow process and uncertainty associated with factors affecting intersection capacity. Therefore, mathematical models are currently used to predict average delays, and are based on simplified assumptions. In general, existing delay models assume vehicles arriving follow a Poisson distribution process, which is a constant flow rate. Fu and Hellinga (2006) investigated the root source of delay variability at intersections by using lognormal distributions. The results indicate that the model can be a useful tool for analyzing variations behaviour and evaluating the LOS at an intersection. Delay variation is one of the essential performance indicators used to

determine the LOS at signalized intersections. It is a focus of this research to establish the delay time variation distribution for the five main corridors in Dar es Salaam city.

## **2.5 Travel Time Measures**

Travel time is the time required to traverse a route between any two points of interest, and is a fundamental measure of the efficiency of the transportation system. Travel time is a simple concept, understood and communicated by a wide range of audiences, including transportation engineers and planners, business persons, commuters, media representatives, administrators, and consumers. Engineers and planners have used travel time and delay studies since the late 1920s to evaluate transportation facilities and plan improvements (Webster, 1958). Commuters may spend 20 to 30 minutes traveling one-way in their commute from home to work to ensure they arrive on time. Various media reports travel times on urban road networks and streets by informing road users of potential travel delays, typically from 10 to 15 minutes, on different parts of the network. There are various techniques used to acquire urban travel time information, based on needs and available tools. Travel time measures and approach techniques have been discussed in many previous studies (Jiang et al., 2014; Salonen & Toivonen, 2013; Vanajakshi et al., 2016). A general overview of the various techniques is provided in the following subsections.

### **2.5.1 Measure Techniques of Travel Time**

The existing body of research on travel time suggests that the measurement of urban travel time can be categorized into two primary groups: fixed and mobile tools (Turner et al., 1998; Zheng, 2011). The first group involves fixed sensors installed along the roads, such as Automatic Number Plate Recognition (ANPR), cameras, Bluetooth scanners, Inductive Loops Sensors, and Automatic Vehicle Identification, to monitor traffic flow. Furthermore, Yeon et al., (2008) suggested that fixed sensors can be divided into point and interval sensors.

### **2.5.2 Point Sensors**

Point sensors are usually fixed along the roads to capture traffic flow at a specified point, as shown in Figure 2.6. Moreover, Mori et al., (2015) categorized point sensors into two groups: single induction loop detectors and double loop detectors. Single loop detectors consist of a single induction loop, which generates a magnetic field enabling detection of the passage of large metallic objects, such as vehicles. Information obtained from these sensors includes the number of vehicles passing through the intersection (vehicles/hour) and the percentage of time that the detector is occupied (occupancy). Krishnamoorthy (2008) predicted urban travel time using single Inductive Loop Detectors (ILDs) placed on urban roadways to monitor traffic flow. While this approach is effective in measuring urban travel time, it is limited by the availability of sensors in the area of the study.

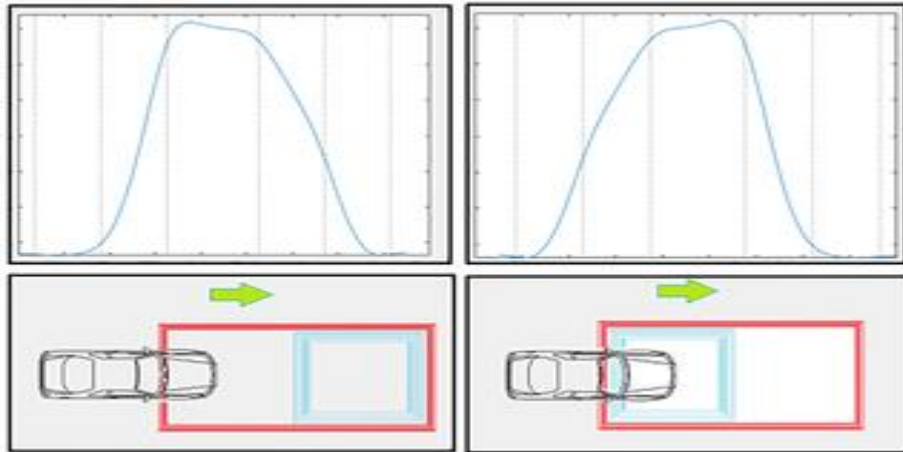




**Figure 2.6:** Traffic Source Data; Point Sensor. (Dutch National data, 2018)

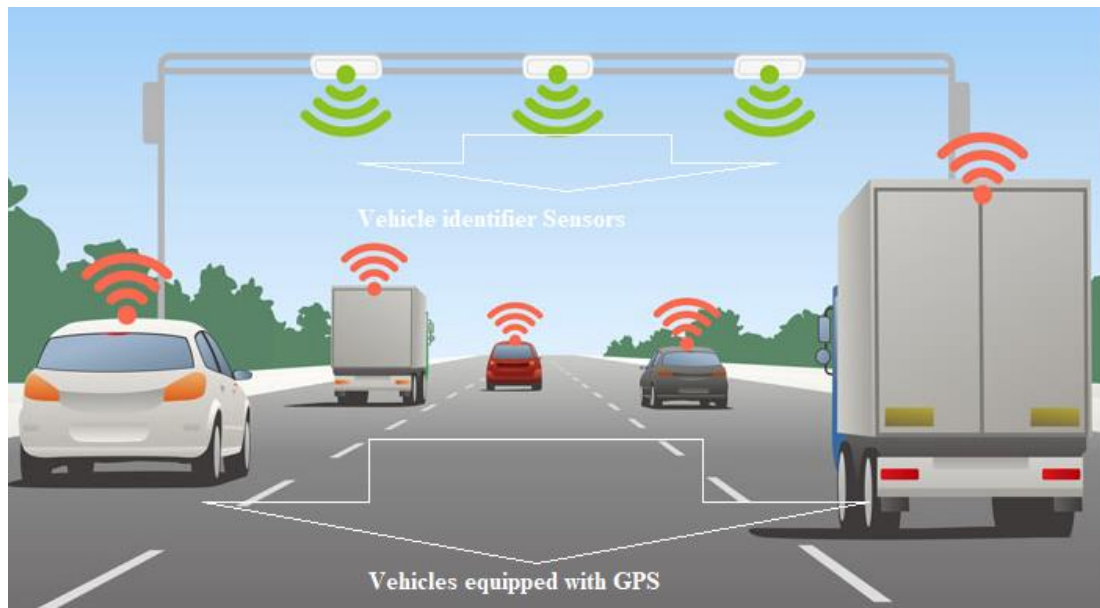
### 2.5.3 Double-loop Detectors

Double-loop detectors consist of a pair of single-loop detectors set close enough to each other, as indicated in Figure 2.7. Liu et al., (2005) applied loop detector data to develop a macroscopic urban travel-time prediction model. The pair of sensors can capture traffic flow, occupancy, travel speed, and vehicle lengths by considering the travel time interval between the two sensors (Kwon et al., 2000). However, this method of using loop detectors for data collection is very sensitive with respect to the distance between the two loop detectors; if the distance is too close, it may not be applicable in measuring travel time.



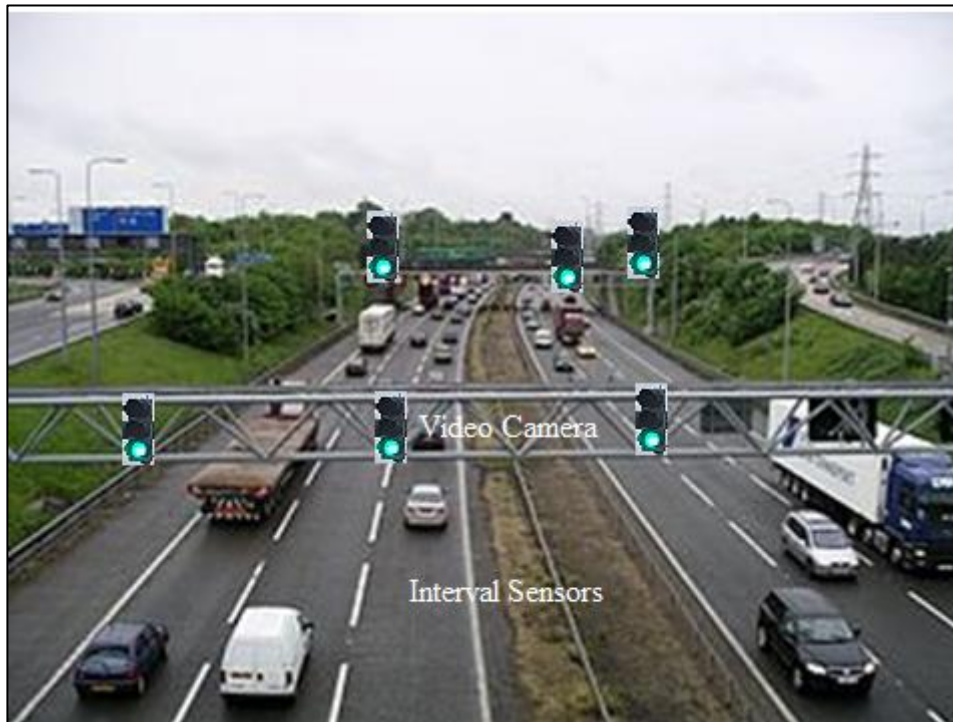
**Figure 2.7:** Double-loop Detectors (Dutch National data, 2018)

Contrary to point sensors, which focus only on one point of the road, interval sensors allow the direct calculation of travel time between two points by finding differences between entrance and exit times in the road segment. Furthermore, Faghri et al., (2014) commented that the combination of fixed and mobile sensor techniques can be applied to collect traffic data. As illustrated in Figure 2.8, a combined approach may involve floating, testing, or probe vehicles, equipped with sensors (Mobile phone or GPS), collecting data in parallel with road sensors to detect crossing vehicles at different points in the road network



**Figure 2.8:** Traffic Source Data; Probe Sensor (Dutch National data, 2018)

Vehicle identification techniques can either be done manually or automatically, by recording a vehicle's plate number or stamp marks (Bacon et al., 2011). The devices detect and recognize vehicles at the beginning and end of the segment, whereby travel time is calculated directly from the starting and ending time. As shown in Figure 2.9 the pair of sensors is mounted along with roadside beacons, such as video cameras, and Bluetooth and Wi-Fi are applied to capture the information (Jeong and Rilett 2004). However, this technique may not be applicable in most developing countries, due to the high costs of purchasing and installing road sensors.



**Figure 2.9:** Traffic Source Data; Interval Sensor. (Dutch National data 2018)

Zheng (2011) described mobile sensors as position detection equipment, such as GPS sensors, satellite sensors, and cell phone sensors, that directly provides travel time, from point-to-point, on the route crossed by probe vehicles, testing vehicles, and floating vehicles. Turner et al., (1998) categorized mobile sensors into three groups: testing, floating, and probe vehicles. These types of vehicles are equipped with sensors (i.e., mobile phones or GPS), which are capable of detecting information, such as location, direction, and speed at different time intervals as indicated in Figure 2.9 (Kwon et al., 2000). The vehicles can be personal cars, public transport vehicles, or commercial vehicles (Mori et al., 2015). The difference between testing, floating, and probe vehicles is that testing and floating vehicles are vehicles that operate under predefined checkpoints and specified routes, for the purpose of traffic data collection. Probe vehicles operate on undefined routes, at

undefined points, recording and storing traffic flow data at any time. Also, the testing and floating vehicles operate under instructions, such as speed, specified route, or time of the day, which is quite different from the probe vehicle method. The process of data collection using testing, floating, and probe vehicles can be performed manually, whereby stopwatches or notebooks are used inside the vehicles to record travel time at specified points or routes.

The main advantage of using the probe vehicle method is that probe vehicles can collect extensive travel time information continuously, and at a reasonable price, if road sensors are available on the streets where the vehicle operates (Jiang et al., 2014). Another advantage is that the data collected can be electronically formatted in a different format, which assists in data processing and transmission from the vehicles to data storage (Gurmu et al., 2014). However, the limitations of this method are that probe vehicles involve a high initial cost for purchasing the necessary equipment, installation costs, and training of personnel to operate the system (Abdalla and Abdel-Aty, 2006).

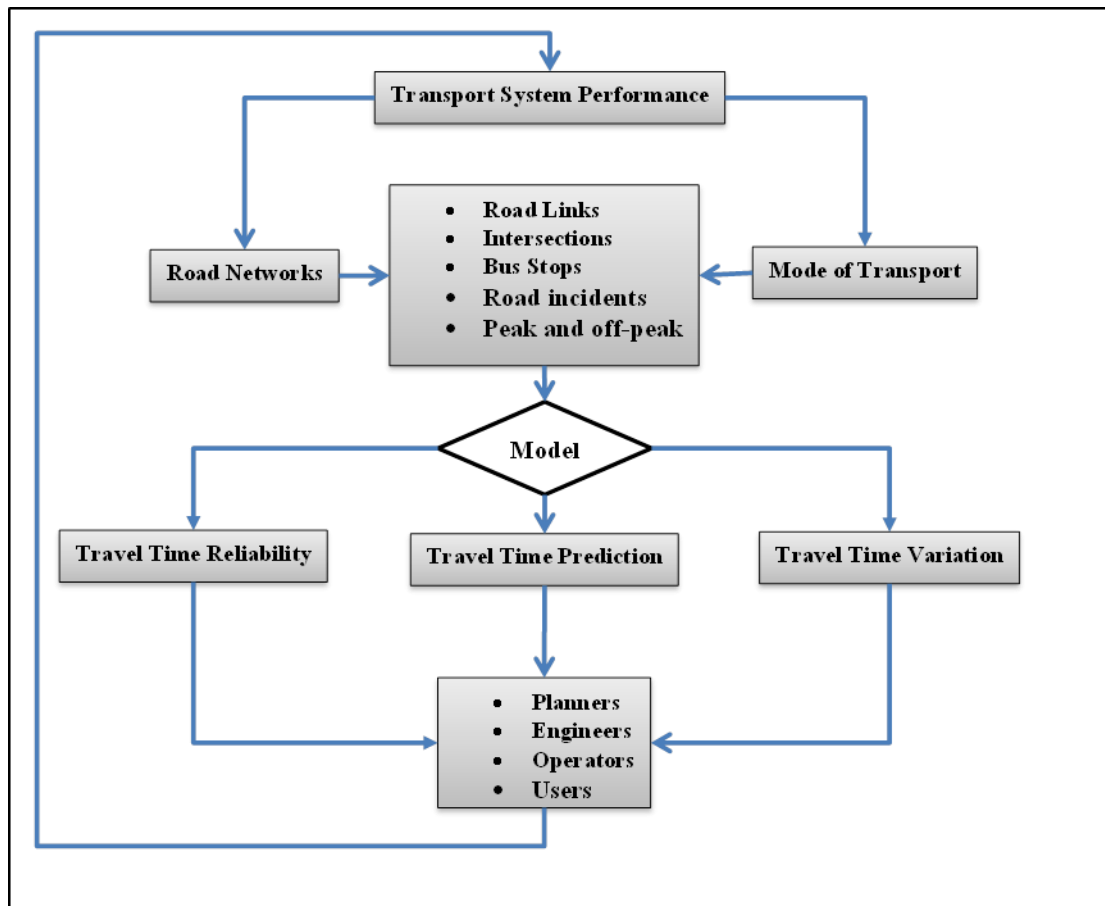
Testing and floating vehicles operate under defined driving styles, which provide consistent and detailed data that covers the entire study area (Turner et al., 1998). However, both testing and floating vehicles are subject to a higher risk of potential human error, which requires substantial time for checking the quality of data. Furthermore, if the data required demands detailed information, the ability to store large amount of data is needed, which may not be available (Jiang et al., 2014).

Many researchers have utilized both fixed and mobile sensor methods to collect travel time data. Fixed sensor techniques require a substantial investment in road sensors along the urban roads, which are not available in most of developing

countries, such as Tanzania (Jain et al., 2012; Sen et al., 2011). However, the mobile sensor method (testing, floating, and probe vehicles) is associated with considerable initial cost to purchase equipment, as well as installation, maintenance, and training costs. These costs are affordable compared to fixed sensors (Bacon et al., 2013; Krishnamoorthy, 2008). Therefore, this research applied testing and floating vehicles to collect travel time data, while waiting time at bus stops was collected by observing and recording the dwell time of a vehicle at the bus stop, along the five main corridors in Dar es Salaam.

## **2.6. Urban Travel Time Conceptual Framework**

The travel time conceptual frame explains the main components used to evaluate urban travel time. As indicated in Figure 2.10, these components include: travel time prediction, travel time reliability, and delay variation. Furthermore, it shows the application of these main components to evaluate urban transport system performance.



**Figure 2.10:** Urban Travel Time Model Concept

### 2.6.1 Summary

### 2.6.2 Literature gaps

The study of modeling travel times in homogenous traffic flow conditions has received considerable attention from many researchers. However, there are limited studies regarding urban travel time modeling, especially related to developing countries, such as Tanzania, where traffic flow is heterogeneous. Alternatively, a number of urban travel time prediction models have been established for road networks in developed countries, under homogenous traffic conditions. In this chapter, urban travel time prediction models, travel time reliability, and delay variation at intersections, for heterogeneous traffic flow conditions, are discussed.

### **2.6.2 Methodological gaps**

A state-of-the-art overview of urban travel time prediction models was thoroughly discussed, including a discussion on the advantages and disadvantages of these models. It appears that most of the existing models did not take into account heterogeneous traffic flow conditions (e.g., uncertainty delay at intersections and waiting time at bus stops) in developing countries. Moreover, most of the existing models, include both model-based and heuristic models, aimed at predicting the average travel time. Most research efforts have been directed towards bus travel time prediction under scheduled urban transport system. Moreover, the main component of bus travel time is the scheduled delay time at bus stops which is occasion on most of the urban transport system in developing countries, including Tanzania. Therefore, this research will incorporate these unscheduled delays time at bus stops in the prediction model for better prediction of urban travel time.

Therefore, one goal of this research has been developing dynamic bus travel time prediction model for determining travel time in a meaningful manner. Also, to describe travel time reliability under heterogeneous traffic flow conditions, by applying buffer time, standard deviation, coefficient of variation, and planning time. Finally, the research attempts to establish a delay variation at the intersections which is an essential component of travel time on urban roads. The delays uncertainties due to traffic lights and police control have been considered in this research by applying probability distribution at intersections.



## CHAPTER 3 – STUDY AREA AND DATA COLLECTION

### 3.1 Description of the Study Area

#### 3.1.1 Study Area Location

The City of Dar es Salaam is located at 6°48' South, 39°17' East (6.8000, 39.2833) on a natural harbor on the eastern coast of East Africa, with sandy beaches in some areas. The city's land area is 538 square miles (1,393 square kilometers), with a population density of 8,100 people per square mile (3,100 per square kilometer). According to the Tanzania Bureau of Statistics, the population of Dar es Salaam grew from 6.4 to 6.7 million people from 2019 to 2020, respectively, a 5.24% annual growth rate. The commuting area has expanded to 30 Km away from the city center. Dar es Salaam encompasses a large regional area, divided into five districts listed in Table 3.1.

**Table 3.1:** Districts of Dar es Salaam

<b>District</b>	<b>Population (2012)</b>	<b>Area km<sup>2</sup></b>
Ilala	1,220,611	210
Kinondoni	929,681	270
Ubungo	845,368	261
Temeke	1,205,949	145
Kigamboni	162,932	507
<b>Dar es Salaam Region</b>	<b>4,364,541</b>	<b>1,393</b>

**Source:** Tanzania based on Population and Housing Census 2012

Dar es Salaam is a mono-centric structure city that has only one Central Business District (CBD), which includes the city center and Kariakoo. The arterial roads originate from the residential areas towards the CBD and two outer beltway roads, as shown in Figure 3.1. This road network configuration suggests that social services and economic activities, such as government and private offices, education

institutions, supermarkets, financial institutions, and the Dar es Salaam port (import and export goods) are located in the city center. Most of the commuters tend to travel from the outskirts towards the CBD. This situation causes rapid and unpredictable traffic flow towards the CBD during peak hours. Traffic flows in one direction during the morning hours towards the city center and vice versa in the evening. As a result, there is heavy congestion during the peak hours.



**Figure 3.1:** Main Corridors in Dar es Salaam City (Field Data, 2019)

Traffic congestion occurs at the major trunk roads, including Bagamoyo Road, Old Bagamoyo Road, Morogoro Road, Nyerere Road, and Kilwa Road, which are the major entrances to the CBD during peak hours in the morning and evening time. Furthermore, serious congestion happens at intersections located along these major trunk roads, such as Mwenge intersection, Morocco intersection, Selander Bridge, Magomeni, intersection, Ubungo intersection, Buguruni intersection, Uhasibu intersection, and Tazara intersection. The existing trunk roads in DSM (such as Bagamoyo Road, Morogoro Road, Nyerere Road, and Mandela Road) do not have alternative routes that can be used as a detour.

### **3.1.2 Survey Corridors**

The survey was conducted along five main routes: Mbagala-Kariakoo (via Kilwa Road), Pugu-Kariakoo (via Nyerere and Uhuru Roads), Mbezi-Kariakoo (via Morogoro, Mandela, and Uhuru Roads), Tegeta-Kariakoo (via Bagamoyo, Ali Hassan Mwinyi, and United Nation Road), and Kawe-Kariakoo (via Old Bagamoyo and Kawawa Roads). These routes were selected because a majority of commuters use them when making trips to the CBD, and they have direct connections to the residential areas. Also, the routes provide a link between the Dar es Salaam Port Authority and other parts within and outside of the country.

### **3.2 Research Methodology**

A quantitative approach was adopted for this research, because the study required gathering numerical data to perform statistical analyses. The survey was conducted to collect link distance, link travel time, delay time at the intersections, and waiting

time at the bus stops. This research approach utilizes quantitative research methods to predict urban travel time, travel time reliability, and delay variation at the intersections.

### **3.2.1 Data Collection Methods**

The travel time survey was conducted in February 2017 for the secondary data, and from September 2018 to January 2019 for the primary data, on the five corridors in Dar es Salaam city. Testing and floating vehicles (commuter buses known as Daladala) were used to collect travel time data along the corridors. Surveyors used vehicles (Daladala) that operate on the five main corridors: Mbagala-Kariakoo, Pugu-Kariakoo, Mbezi-Kariakoo, Tegeta-Kariakoo, and Kawe-Kariakoo. Daladala drivers operated based on either the prevailing speed or traffic flow conditions. In addition, the selected Daladala were instructed to not overtake other vehicles, but instead, to follow behind other vehicles in the traffic stream. The surveyors recorded the departure time at the beginning of the route, and the time and distance, using odometer readings, at checkpoints (i.e., intersections and bus stops) along the route. Surveyors also documented the reason and duration of each stop/delay, and the time of arrival at the end of the route. Data for each direction on each route segment were recorded separately for the morning peak, evening peak, and off-peak periods.

The waiting time at the intersections and the bus stops was obtained through observation in the field. Arrival and departure times of vehicles at the intersections or bus stops were recorded manually for each direction of travel.

The traffic count data were collected by the JICA, in collaboration with the NIT, from the NIT database. A total number of 17 points were surveyed, as indicated in Table 3.2. The surveyors counted all vehicles, in both directions, based on type,

size, direction, and vehicle purpose. The numbers of vehicles were recorded manually on a survey form, and the number of vehicles by direction, and by vehicle type, was recorded on a summary form every fifteen (15) minutes. A sample of each form is shown in Figures 3.1 and 3.2, Appendix 3.0.

**Table 3.2:** Traffic Flow Count Points

<b>Corridors</b>	<b>Survey Time (hrs)</b>	<b>Name of points</b>	<b>No. of Points</b>
Tegeta-Kariakoo	14 and 24	Tegeta, Makongo, Millenium, Osterbay, and Salender	5
Mbezi-Kariakoo	14	Mbezi (Mkaa), Kibo and Tabata Sukita	3
Pugu-Kariakoo	14	Ukonga and Tazara	2
Mbagala - Kariakoo	14	Railway Bridge, Mivinjeni and Mbagala Mission	4
Kawe - Kariakoo	14	Mlalakua, Mkwajuni and Kigogo Sambusa	3
<b>Total</b>			<b>17</b>

### 3.2.2 Survey Duration

Travel time data were collected on weekdays (Monday to Friday) for each week between September 2018 and January 2019, on each of the five study corridors. Weekend days (Saturdays and Sundays) were excluded in the sample since commuter traffic and traffic flow in the city is very low on the weekends. The surveys involved 28 trips per corridor per day, beginning at 06:00 hours and ending at 19:00 hours. Each collection period was divided into two groups: off-peak hours and peak hours. For the inbound directions (traveling to the CBD), morning peak

hours occurred from 06:00 to 11:00 hours, and off-peak hours occurred from 11:00 to 19:00 hours. A reverse of traffic flow occurred in the outbound directions, with off-peak hours occurring from 06:00 to 14:00 hours, and peak hours occurring from 14:00 to 19:00 hours. During the data collection period, no major weather issues were reported (i.e., rains or floods) that might have affected travel time. Travel time data were collected for 14 hours, in one-hour increments, for three weekdays of each week in the study period, for both directions of travel (inbound and outbound) on the five study corridors. This methodology was used to ensure a sufficient sample size. The sample size was obtained by the multiplying the survey time, number of directions, number of survey days, and the number of links for each study route. Table 3.3 summarizes the travel time data collection effort.

**Table 3.3:** Surveyed Area and Duration

Corridors	Survey Time ( hrs )	Trips	Days	Total Trips	Links	Total Trips
Tegeta-Kariakoo	14	28	3	84	5	420
Mbezi-Kariakoo	14	28	3	84	3	252
Pugu-Kariakoo	14	28	3	84	3	252
Mbagala-Kariakoo	14	28	3	84	2	168
Kawe - Kariakoo	14	28	3	84	3	252
Total				420	11	1344

### 3.2.3 Data Collection Procedures

The data collection duration was extended to allow surveyors to undergo training, overcome personnel issues, conduct equipment troubleshooting, and identify unusual

traffic conditions. Supervisors outlined the rules and procedures for data collection to avoid biases, particularly for traffic flows that show extreme or unusual behaviour. Extreme or unusual conditions, such as heavy rain, severe accidents, unusual delay time at the intersections (e.g., traffic police control instead of traffic lights), and equipment malfunction (e.g., dead batteries and network status) were noted for further reference to ensure the quality of the data collected (Turner et al., 2008).

Furthermore, qualitative information, such as weather conditions (e.g., sunny, rainy), pavement conditions (e.g., dust, potholes), unusual traffic conditions or incidents, and media reports about construction occurrences were reported. Other special events that might affect traffic flow were also noted during data collection, as shown on the sample survey form in Table 3.2, Appendix 3.0. This provided useful information during data reduction and analysis.

#### **3.2.4 Surveyors Training**

The attitude and knowledge of surveyors towards data collection play a significant role in the quality of the collected data (Faghri et al., 2014). To enable the surveyors to collect the appropriate data in the intended area on time, each surveyor was well-trained to comply with techniques, rules, and procedures, especially with setting up survey tools, accurately recording and completing survey forms, and note unusual situations. The training was accomplished by doing simple exercises, such as how to set and read a stopwatch and how to complete the survey forms.

### 3.2.5. Sample Size

The sample size refers to the number of observations gathered from the urban trips, to represent the entire population of urban trips (Ernst et al. 2012). It explains the extent travel times are measured by testing vehicles to represent the mean population. Having an appropriate sample size is essential in finding a statistically significant result. The larger the sample size, the more reliable the results; however, a larger sample size requires more time and money. The statistical sampling methodology can determine the minimum required number of testing vehicles that would provide reliable link travel time estimates. The minimum sample sizes used ensure that the number of trip runs must represent a true average travel time within a specified error range of the entire population. For this case, the sample size considered was the number of trips made by the probe vehicles.

Turner et al. (2008) proposed a mathematical model for estimating a sufficient number of vehicle tests for collecting travel time data, with the assumption that travel time on a particular link is an identically and independently distributed random variable, as indicated in Equation 3.2.1. Thus, the number of testing vehicles required, based on this model, is computed using Equation 3.2.1.

$$n_{it} = \left( \frac{1.96 \times \sigma_{it}}{\varepsilon_{\max}} \right)^2 \quad 3.2.1$$

where,

$\sigma_{it}$  is the Standard deviation,

$n_{it}$  is the number of sample size,

$\varepsilon_{\max}$  is the maximum relative error, and

1.96 is the 95% confidence



Equation 3.2.1 was employed as a statistical sampling method to obtain a minimum number of test vehicles corresponding to a pre-specified permitted relative error and confidence level. The method was applied using standard deviation of 0.657 with maximum error rate of 0.05 and 95% confidence in each direction (inbound and outbound) which results to 663 numbers of trips in five in each direction. Therefore, from equation 3.2.1 was used to calculate the sample size of the five main corridors in Dar es Salaam city as shown in Table 3.4.

**Table 3.4:** The Proposed Sample Size

<b>Name of Corridors</b>	<b>Trips</b>	<b>Days</b>	<b>Links</b>	<b>Sample</b>
Tegeta-Kariakoo	28	3	5	420
Kawe-Kariakoo	28	3	3	252
Mbezi -Kariakoo	28	3	3	252
Pugu -Kariakoo	28	3	3	252
Mbagala-Kariakoo	28	2	3	168
<b>Total Sample Size</b>				<b>1344</b>

### **3.2.6 Pilot Survey**

A pilot travel time survey was conducted before the full data collection survey began. The purpose of the pilot study was to familiarize the surveyors with the collection tools, identify the checkpoints, identify existing or potential problems arising during data collection, and determine the necessary resources required. Data collected during the pilot survey were used to check the quality of traffic data and to adjust the sample size. Furthermore, data obtained during the pilot survey served as a benchmark, to be used to adjust the data collected from the field to ensure quality (Kumar, et al., 2017).

### **3.3 Data Collection**

### 3.3.1 Primary Data Collected

The data were collected hourly, from 6:00 to 20:00 hours on the five main corridors which include each link names, link distance, number of bus stops and intersections as the route attributes as shown in Table 3.5.

**Table 3.5:** The Corridors and their attributes

Corridors	Link Name	Length (Km)	Bus Stops	Intersections
Tegeta-Kariakoo	Tegeta-Africana	5.5	8	2
	Africana-Mwenge	7.2	9	4
	Mwenge-Victoria	3.4	6	2
	Victoria- Mbuyuni	2.4	2	2
	Mbuyuni-Kariakoo	6.7	7	5
Mbezi-Kariakoo	Mbezi-Ubungo	12.5	12	2
	Ubungo-Buguruni	7.5	11	3
	Buguruni-Kariakoo	3.6	7	2
Pugu-Kariakoo	Pugu-Aiport	11.3	15	1
	Aiport-Buguruni	7.5	5	4
	Buguruni-Kariakoo	3.6	8	2
Mbagala-Kariakoo	Mbagala-Uhasibu	7.0	10	1
	Uhasibu-Kariakoo	5.0	10	1
Kawe-Kariakoo	Kawe-Morocco	7.2	11	1
	Morocco-Magomeni	3.8	6	4
	Magomeni-Kariakoo	3.2	4	2

### **3.3.2 Secondary Data**

This study used secondary data, which were collected by JICA in collaboration with the NIT in 2017 and available in the National Institute of Transport (NIT) database. A total number of seventeen (17) points were surveyed, as indicated in Figure 3.6. Some of the data were collected in 14 hours and others in 24 hours. Since the travel time survey was conducted from 6.00 to 20.00 hrs the data were merged. For example, for the case of travel time survey when a trip was made from 6.00 to 8.00 hrs, the traffic flow data collected at this time was considered the precise traffic flow of the time.

The traffic survey was done in 29 points, whereby 15 points were screened line survey, which was conducted across the rivers and railways in the five main corridors. The other 14 points were conducted in deferent locations in the five main corridors, as in Figure 3.2.



### *3.3.2.1 Traffic Data compositions*

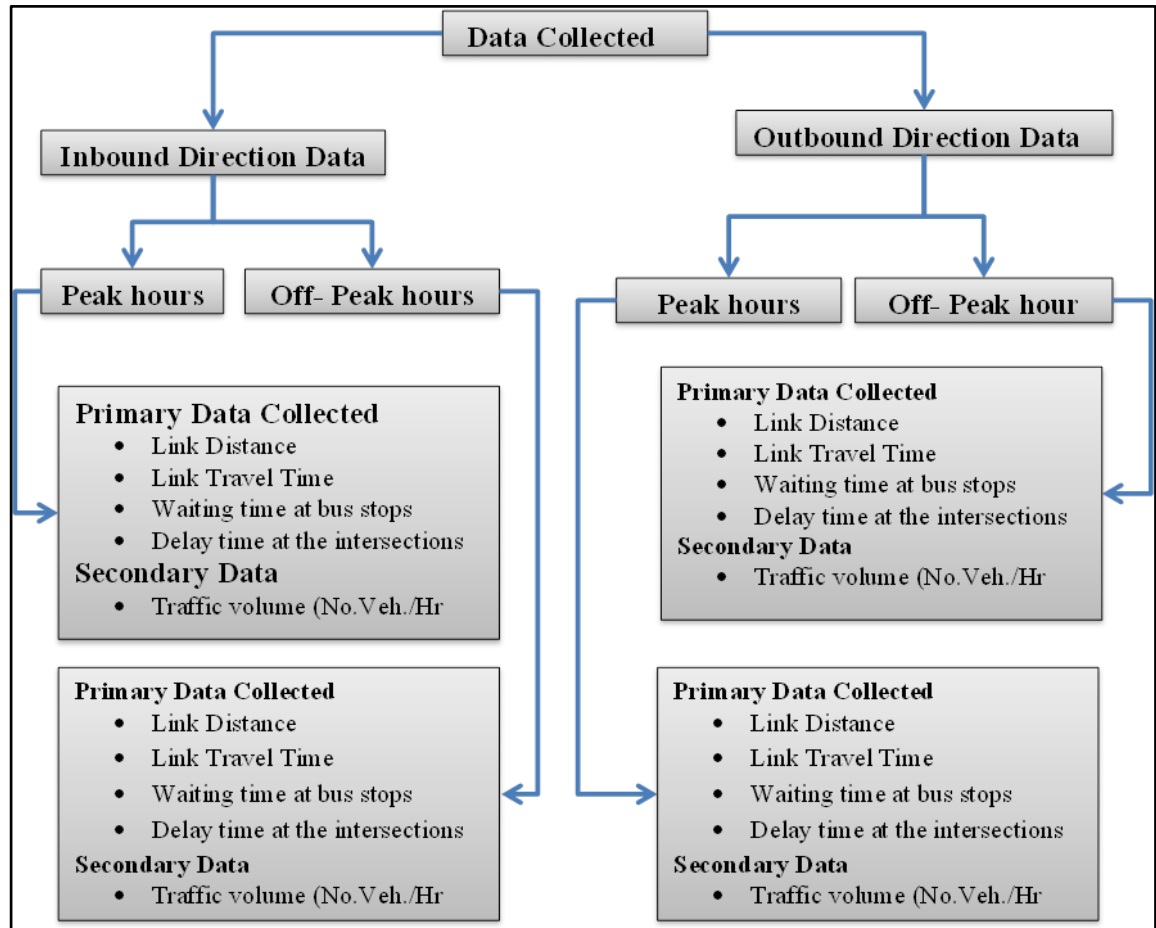
The secondary data compares different various numbers of modes of transport includes from small size to large size, motorized to non –motorized, and low speed to high speed as indicated in the Table 3.6

**Table 3.6: Heterogeneity of traffic flow in Dar es Salaam**

Vehicle composition	Mbezi-Kariakoo		Pugu - Kariakoo		Mbagala-Kariakoo		Kawe- Kariakoo		Tegeta-Kariakoo	
	Inb-Tv	Outb-Tv	Inb-Tv	Outb-Tv	Inb-Tv	Outb-Tv	Inb-Tv	Outb-Tv	Inb-Tv	Outb-V
	122580	117789	130444	113292	101955	98211	165750	142542	313887	316932
Passenger Cars	37.0%	30.5%	31.8%	35.6%	46.4%	50.8%	61.6%	59.0%	44.8%	46.7%
Tax	0.1%	0.1%	0.6%	0.4%	3.2%	1.0%	1.0%	1.5%	0.1%	0.2%
Pick-up and Van	2.6%	5.3%	1.8%	2.4%	3.7%	2.9%	4.0%	4.9%	3.7%	4.0%
Microbus (Dala)	0.3%	0.4%	0.5%	0.4%	0.6%	0.3%	0.7%	0.9%	0.7%	0.5%
Median (Dala)	13.0%	12.3%	23.0%	23.9%	15.9%	15.1%	4.0%	5.0%	14.0%	12.8%
Large Bus	3.5%	4.4	0.0%	0.0%	0.0%	0.1%	0.0%	0.0%	0.0%	0.0%
Organization bus	1.4%	1.7%	0.7%	0.6%	0.5%	0.8%	0.6%	1.0%	1.5%	0.7%
2 Axle Trucks	3.5%	8.3%	4.9%	5.4%	2.4%	2.7%	1.7%	2.7%	6.5%	5.7%
3 Axle Trucks	5.0%	0.7%	1.0%	1.0%	1.2%	1.5%	0.2%	0.0%	1.3%	1.5%
Heavy Trucks	5.8%	0.6%	0.7%	0.7%	2.7%	2.5%	0.0%	0.0%	1.3%	0.9%
Bajaj (3wheels)	5.2%	4.5%	2.9%	2.4%	1.4%	1.3%	10.8%	9.5%	7.5%	7.8%
Motorcycle	22.6%	25.0%	29.5%	25.5%	19.6%	17.3	11.0%	11.0%	17.4%	18.9%
Non-Motorized	0.6%	0.8%	2.5%	1.8%	3.3%	1.4%	4.4%	4.4%	1.1%	1.0%

The data collected were based on the direction of travel, i.e., inbound and outbound.

Figure 3.3 illustrates the data collection process



**Figure 3.3:** Primary and Secondary Data Collected in all directions

### 3.3.3 Data Collection Instrument

The traffic flow data were collected using the following instruments as shown in Table 3.7.

**Table 3.7:** Data Collection Tools

Supporting Tools	Data recoding Tools
<ul style="list-style-type: none"> <li>• Dar es Salaam survey map which shows the city road networks</li> <li>• A list of the checkpoints</li> </ul>	<ul style="list-style-type: none"> <li>• Survey forms</li> <li>• Stopwatch</li> <li>• GPS equipment</li> </ul>

<b>Supporting Tools</b>	<b>Data recoding Tools</b>
<ul style="list-style-type: none"> <li>• A list of link names showing the start and end of the links</li> <li>• Bus fare for each surveyor</li> <li>• ID Card</li> <li>• Survey time table</li> </ul>	<ul style="list-style-type: none"> <li>• Pencil and rubber</li> <li>• Testing vehicle and Daladala</li> <li>• One PC computer (PC) and lap top computer</li> </ul>

### **3.3.4 Data Processing**

The data gathered from the five main corridors were reviewed and evaluated each day for the purposes of noting the issues that emerged. This enabled the researcher to build on those issues in the next interactions with respondents to ensure consistency, simplification, and harmonization of emerging issues. The data processing started with the preparation and organization of all relevant data gathered from the field. All recorded data were divided into two groups. The first group was used to train the model, and the second group was used to test the model. The data was processed and used to model urban travel time, determine route travel time reliability, and determine delay variation at the intersections on the five main corridors in Dar es Salaam as in Table 3.8



**Table 3.8:** Specific Objectives and Data Required

<b>Objective</b>	<b>Data Required</b>	<b>Data Collection Tools</b>	<b>Analysis Method</b>
To determine the suitable dynamic model for predicting Dar es Salaam city travel time	Link Travel Time Waiting at the bus stop Delay time at the intersections Link length Time of the day Traffic flow	Survey forms Stopwatch GPS equipment Pencil and rubber Testing vehicle and Daladala Computers	XLSTA –Software ANN Multi-Linear Regression Kalman Filter Dynamic Algorithm
To establish travel time reliability under heterogeneous traffic flow condition	Waiting time at the bus stop Delay time at the intersections Link length	Survey forms Stopwatch GPS equipment Pencil and rubber Testing vehicle and Daladala Computers	XLSTA –Software Buffer index Planning Index Standard deviation
To determine delay variation distribution at the intersection under heterogeneous	Waiting at the bus stop Delay time at the intersections Link length	Survey forms Stopwatch GPS equipment Pencil and rubber Computers	XLSTA –Software Probability Delay distribution

### 3.4 Development of Urban Travel Time Model

Travel time is an important parameter used to evaluate the performance of urban road networks. Urban travel time is influenced by many factors that make prediction of travel time a complex task. Direct prediction of urban travel time, using road sensors, is limited due to the high cost of installation and maintenance. In addition, applying existing models, developed under restricted lane homogeneous traffic flow, will not reflect the real traffic flow behavior. Furthermore, direct application of these models in unrestricted lane scenarios, particularly in heterogeneous traffic conditions, will not result in a reliable prediction.

Therefore, this section will present the procedures for developing a new urban travel time model. An Artificial Neural Network (ANN), Multiple Linear Regression (MLR) model, and a Kalman filter algorithm have been developed and compared to obtain an accurate and reliable urban travel time model. The model was evaluated and validated based on field data collected from the five main corridors in Dar es Salaam city. The overview of this section covers the different steps used to develop the urban dynamic travel time model, by examining urban travel time reliability and delay distribution at the study intersections.

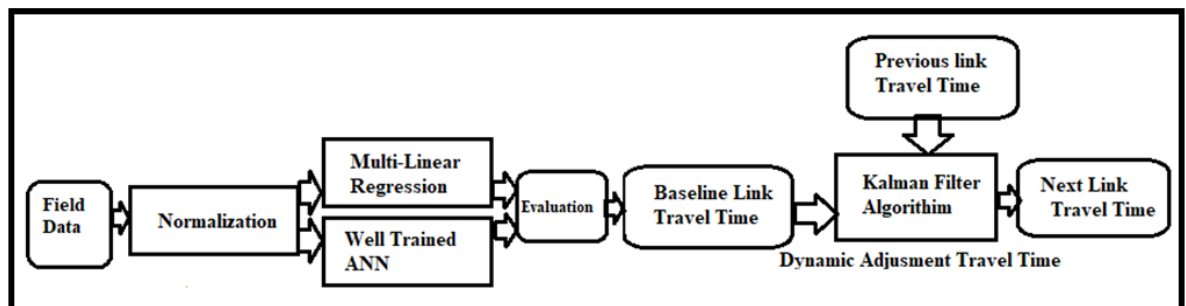
#### **3.4.1 Dynamic Travel Time Model**

The travel time that vehicles experience on an urban road involves both free-flow travel time and delay time. The free-flow travel time was calculated as the distance over the free-flow speed. However, the estimation of delay was more difficult, due to various traffic characteristics on urban roadways, as discussed in Chapter 2. Providing real and accurate travel time information usually assists road users with planning their trips and choosing an appropriate mode of transport. However, precise prediction of travel time is a challenging problem, especially in developing countries where heterogeneous flow conditions exist and there are no records of information about the travel time for travelers.

Most of the dynamic travel-time prediction models that have been developed emphasize link travel time, without taking into account delay time at the intersections and waiting time at the bus stops. This section discusses the development of a prediction model by comparing MLR and ANN to obtain a suitable baseline model to be combined with the Kalman Filter algorithm to produce a dynamic travel-time model. Link travel time, traffic flow, link distance, time of day, and intersection

delay resulting from bus waiting time at bus stops, both at peak hours and off-peak hours, was used as input data into the MLR and ANN models. Both outputs from the MLR model and the ANN were evaluated in terms of R square, Root Mean Square Error (RMSE), and Mean Absolute Percentage Error (MAPE).

The highest performance model, in terms of less percentage error, was considered as the suitable model for link travel time data. The baseline data, from the selected model, were applied as an input to the Kalman Filter dynamic algorithm, in collaboration with the previous link travel time, to obtain the dynamic travel time prediction model for the next link travel time, as indicated in Figure 3.4. The Kalman Filter algorithm was applied to adjust the baseline time data from the MLR or ANN models, in collaboration with the previous link travel time.



**Figure 3.4:** Dynamic travel time prediction Framework

### 3.4.2 Data Descriptions

The data used to develop urban travel time were collected from the five main corridors in Dar es Salaam city in 2017 and 2018. The type of data and the associated units are listed in Table 3.9.

**Table 3.9:** Data Description

<b>Description</b>	<b>Unit</b>	<b>Source</b>
Link travel time	Seconds (sec)	Primary Data
Traffic states (Off-peak or Peak hours)	No unit	Primary Data
Delay time at intersections	Seconds (Sec)	Primary Data
Waiting time at the bus stops	Seconds (Sec)	Primary Data
Link distance	Kilometre (Km)	Primary Data
Traffic Flow volume	Number of the vehicle per hour (No.Veh/hr)	Secondary Data

### **3.4.3 Multi-Linear Regression (MLR) Model**

MLRs are the most common form of linear regression analyses used to build a predictive analysis model. Multiple linear regression is used to explain the relationship between one continuous dependent variable and two or more independent variables, with the assumption that the independent variables are not highly correlated with each other. The main advantage of the MLR model is that it allows a comparison of many independent variables (x) with one dependent variable (y). In addition, it may use different factors and determine the substantial factors which have a high influence on urban travel time. However, MLR models have some limitations, and mainly use incomplete data, which may result in a wrong conclusion.

### **3.4.4 Model Input Data**

The MLR model used data collected from the five corridors in Dar es Salaam city. The independent variables in this model included: the bus waiting time at the bus

stop, delay time at the intersections, link distance, traffic volume, peak hours, and off-peak hours. The dependent variable was the travel time in the links. The data were divided into two sets, with 75 percent of the data used to train the model, and 25 percent of the data used to test the model. The Microsoft XLSTA application was used to analyze the data and evaluate the MLR analysis Model, as indicated in Equation 3.4.1.

$$TT_{sec} = aX_1 + bX_2 + cX_3 + dX_4 + eX_5 + W \quad 3.4.1$$

where,

$TT_{sec}$  is the linked travel time,

$X_1$  is the traffic state (peak hour and off-peak hour are the nominal data), given a value of 1 and 0 for peak hours and off-peak hours, respectively,

$X_2$  is a the bus waiting time at the bus stops,

$X_3$  is the delay time at the intersections,

$X_4$  is the link travel distance,

$X_5$  is the traffic volume,

$a$ ,  $b$ ,  $c$ ,  $d$ , and  $e$  are variable coefficients, and

$W$  is the constant parameter.

### 3.4.5 Model Performance

The prediction results were evaluated in terms of prediction accuracy by the following three measures: the mean absolute error (MAE), the MAPE, and the RMSE. Each measure was calculated as shown in the Equations 3.4.2, 3.4.3, and 3.4.4.

$$MAE = \sum \left| \frac{t_{Observed} - t_{Predicted}}{N} \right| \quad 3.4.2$$

$$MAPE = \frac{1}{N} \sum \left| \frac{t_{Observed} - t_{Predicted}}{t_{Observed}} \right| \quad 3.4.3$$

$$RMSE = \sqrt{\sum \left| \frac{t_{Observed} - t_{predicted}}{N_{Observed}} \right|} \quad 3.4.4$$

Where

$t_{bserved}$  is the observed bus travel time,

$t_{predicted}$  is the predicted bus travel time, and

$N$  is the number of bus trips observed.

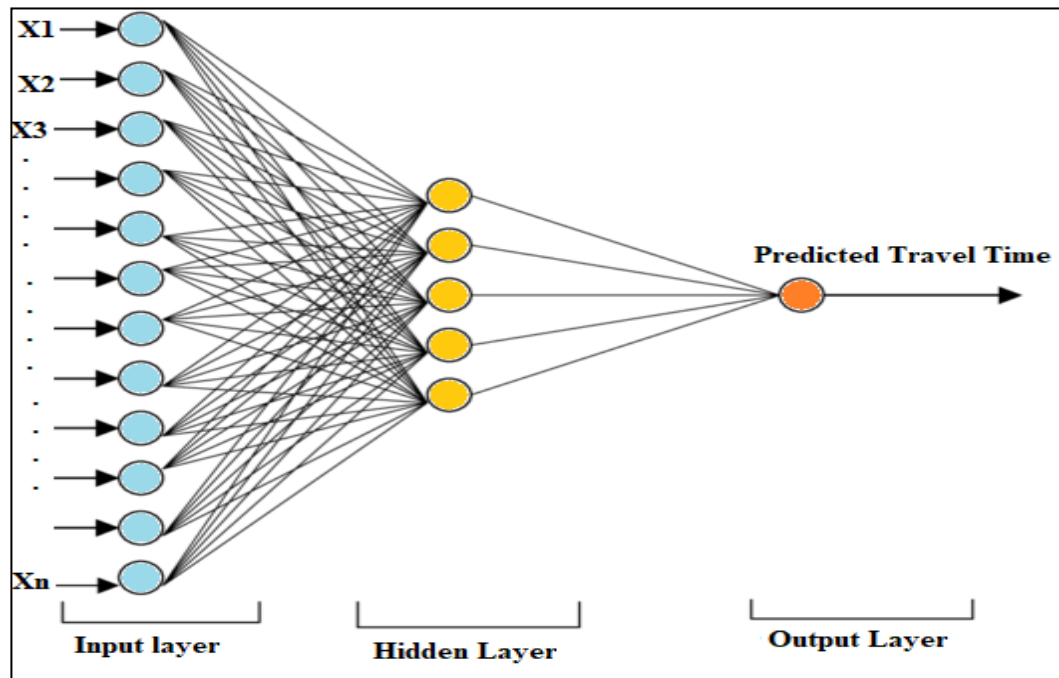
### 3.4.6 Artificial Neural Network

ANN has been widely applied in solving transportation problems because of its ability to manage complex and nonlinear relationships between predictors that arise from large amounts of data, specifically in predicting urban travel time (Bai et al., 2015). It is this unique ability that makes applying an ANN to predict travel time on the five main corridors in Dar es Salaam city appropriate, especially because of non-linearity between factors affecting urban travel time and travel time itself. Fan and Gurmu (2015) applied the ANN model to predict urban travel time. The results indicated that the models can be used to implement in the Information Advance to Public Transport System. Furthermore, Amita et al., (2016) predicted bus travel time using an ANN, and the results revealed that the ANN model outperformed the other models in terms of accuracy and robustness. However, the ANN model is trained

offline, yet it is applied to provide real-time information. The accuracy of the ANN model mainly depends on a sufficient amount of data.

#### **3.4.6.1 The Network Architecture**

ANNs are computing models that process information by replicating the way the biological nervous system functions, such as brain process information (Al-Duais et al., 2013). The network contains a large number of neurons, which are highly interconnected with each other and work together to solve a specific problem (Amita et al., 2015). The ANN architecture is composed of the input layer, hidden layers, and the output layer. The neurons in the input layer are arranged in an orderly manner for prediction, which together, forms the input layer. It is a point where the external data are fed, such as distance, delay time at intersections, and link travel time, as indicated in Figure 3.9. The input layer and the hidden layer neurons are connected by lines with weights, and each connection output provides input to another neuron. In each connection between input and hidden neurons, there is a connection weight so that the hidden neuron receives the product of the value from the input neurons. A neuron in the hidden layer takes the sum of its weighted inputs and then applies activation functions, such as sigmoid or Hyper-tangent functions, to the sum. The results from the activation function then become the input to other neurons of the hidden or output layer. The output neuron takes the weighted sum from the hidden layer as the input of the output neuron and then applies an activation function to the weighted sum. The result of this function becomes the output for the final output of the ANN. The ANN architecture explains how neurons group together and how they interconnect with one another, as well as how the model layers are arranged, as shown in Figure 3.5.



**Figure 3.5:** The Artificial Neural Network Architecture (Da Silva et al., 2017)

### *Input Layer*

The input layer possesses the neurons that receive the initial data from external sources for further processing by subsequent layers. The input layer is the first step of entering data into the workflow for the artificial neural network.

### *Hidden Layers*

The hidden layers are the layers hidden in between the input and output layer, since the output of one layer is the input of another layer. The hidden layers perform computations on the weighted inputs and produce a net-input that is applied to the activation functions to produce the actual output.

### *Output Layer*

This is the last layer that produces the result of given inputs; it is responsible for producing and presenting the final network outputs, which results from the processing performed by the neurons in the previous layers (hidden layer).



### ***Initial weights***

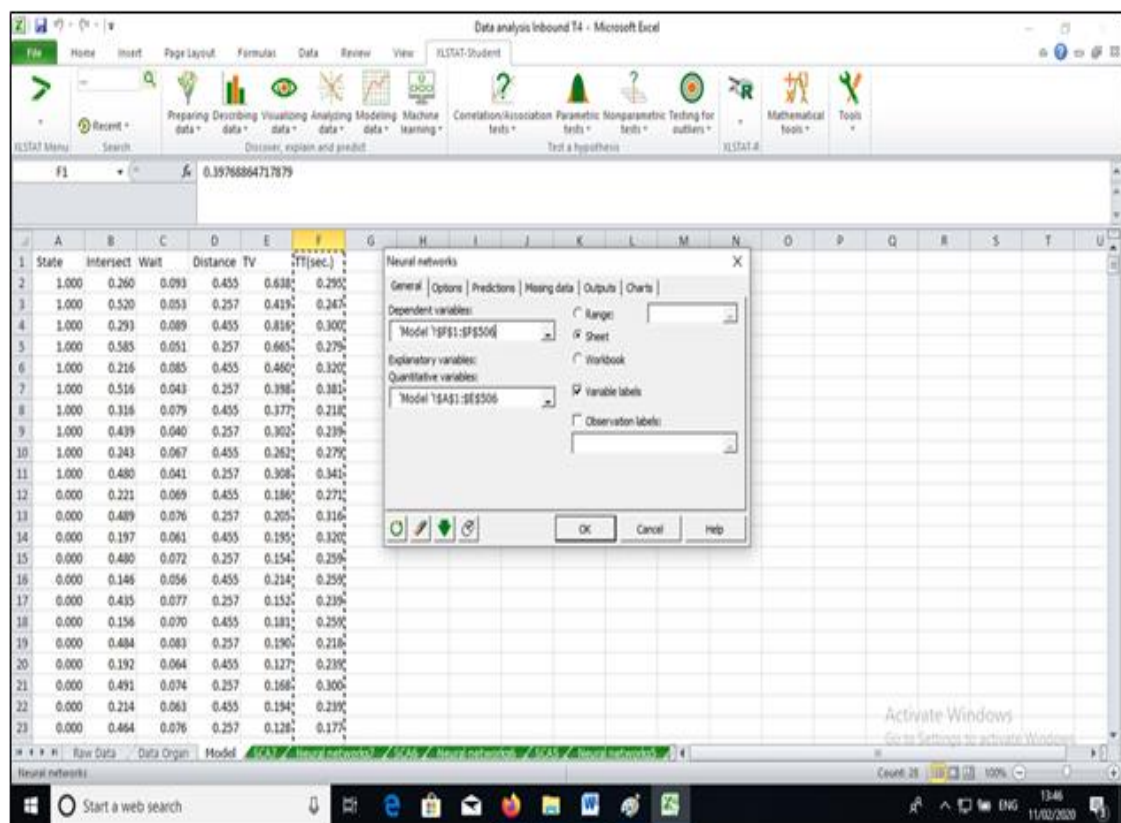
The initial weights of the model were configured by XLSTAT software automatically. The value of weight can be any real number which automatically set by XLSTAT software, that used to initiate the values of the parameters in neural network models prior to training the models. The more training time will be required, if large value of weights will be nominated. Therefore, during the training process the initial weight will be adjusted to reach the optimum weight parameters thus yield the minimum mean squared error

### **3.4.6.2 ANN for Travel Time Prediction**

The same input data was used in the ANN model as was used in the MLR model. The ANN was applied to predict link travel time, as shown in Figure 3.10, and consists of four (4) layers: one input layer with five (5) neurons, one (1) hidden layer with 15 neurons, one (1) hidden layer with 10 neurons, and one output layer with one (1) neuron. The input layer, hidden layers, and output layer are connected by networks (synapses), which carry values known as weights. The input layer contains five variables: X1, X2, X3, X4, and X5. The output layer possesses one dependent variable, which is TT. The X1 variable is traffic state data that is composed of two traffic flow states, peak hours and off-peak hours. The peak hour periods were observed from 6:00 to 11:00 for the inbound direction, and 15.00 to 20.00 for the outbound direction. Off-peak hours were observed from 11:00 to 14.00 for the inbound direction and 6:00 to 15.00 for the outbound direction

### 3.4.6.3 XLSTAT Software

The XLSTAT software was used to simulate urban link travel time. XLSTAT is the statistical analysis add-in in Excel that offers a wide variety of functions to enhance analytical capabilities. It is compatible with all Excel versions, including Microsoft versions 2003 to version 2016 (2011 and 2016 for Mac). XLSTAT-R has option tools with a neural net dialog box, where travel time for the five corridors was inserted as a dependent variable, and five variables, X1, X2, X3, X4, and X5, were inserted as independent variables, as shown in Figure 3.6.



**Figure 3.6:** XLSTAT Software

The input data used for training and testing the models were normalized because the contribution of each input variable greatly depends on the value size of

the other input variables. For example, if the value of the first variable ranges from 0 to 1, and the second variable ranges from 10 to 3000, then, the second variable will dominate the first variable. Therefore, to avoid this confusion, all input and output variables were scaled from 0 to 1 using Equation 3.4.5

$$Y = \frac{X - X_{Min}}{X_{Max} - X_{Min}} \quad 3.4.5$$

where,

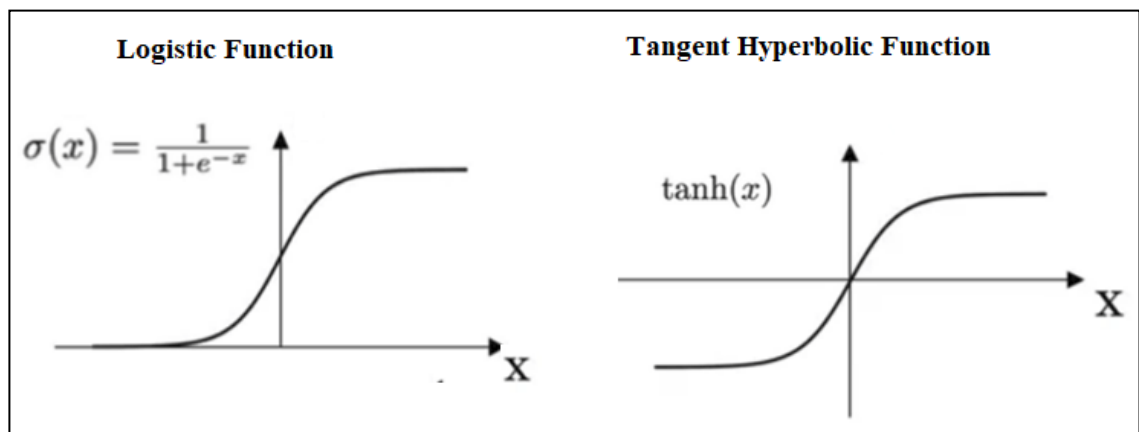
$Y$  is the normalized value,

$X$  is the targeted variable,

$X_{min}$  is the minimum value of a variable, and

$M_{max}$  is the maximum Value of a variable.

The activation function is introduced as a non-linear relationship between the input layer and the output layer. The sigmoidal function, such as logistic and tangent hyperbolic, is common because of its ability to normalize the input values to the range from negative one to one (-1, 1), as indicated in Figure 3.7.



**Figure 3.7:** Artificial Neural Network Activation Function (Fan and Gurmu 2015)

Most researchers have preferred to use logistic and tangent hyperbolic to predict urban travel time, because they can produce positive and negative values and are easier in training (Fan and Gurmu, 2015; Amita et al., 2016; Čelan and Lep, 2017; Zhu et al., 2018). This research used the tangent hyperbolic function as an activation function, whose values range from a negative one to one (-1, 1), as in Equation 3.4.6.

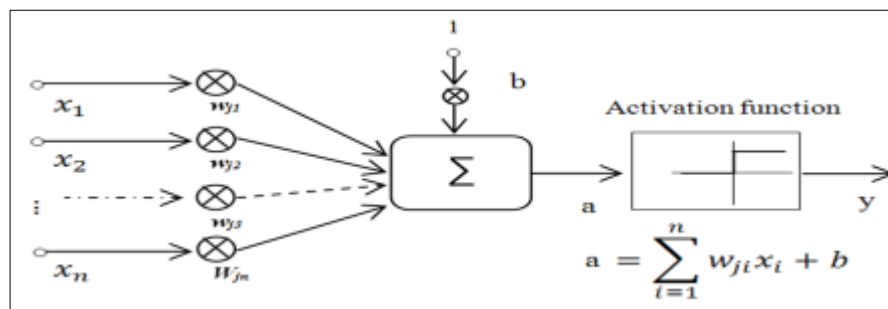
$$\varphi(x) = \frac{e^x - e^{-x}}{e^x + e^{-x}} \quad 3.4.6$$

where,

$\varphi(x)$  is the activation function, and

$e^x$  is the natural logarithm of variable  $x$

The training proposed in this model is a resilient back-propagation algorithm that is commonly used in many studies dealing with urban travel time prediction (Fan and Gurmu, 2015; Amita et al., 2016 and Al-Duais et al., 2013). The main objective of the training is to prove weights ( $w_{ij}$ ) that minimize the mean square error, as shown in Figure 3.8.



**Figure 3.8:** Artificial Neural Networks Model Training Process (Da Silva et al., 2017)

### ***Training and Setting Process of Artificial Neural Network***

The XLSTAT- neural net toolbox was set as follows:

Number of neurons per hidden layers: 15, 10;

Threshold: 0.01;

Maximum steps: 100000;

Repetitions: 1;

Algorithm type of algorithm: (Resilient backpropagation) RProp+;

Error function: Squared errors;

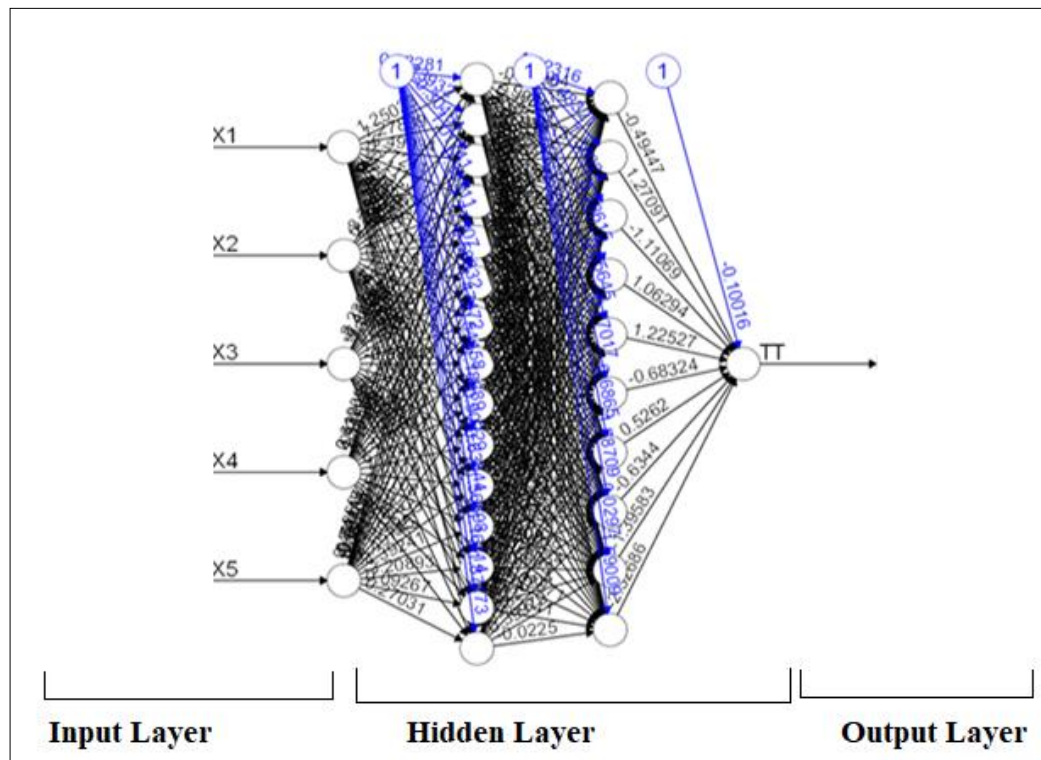
Activation function: Tangent hyperbolic; and

Training Testing and Validation,

Validation and testing of the neural network are essential to justify the reliability of the ANN model and verify if it is sufficient for predicting urban travel time. Therefore, the collected data were divided into two sets. One set was used for training the model, and the other set was used to validate and test the model during the model development. The validation processes took place during model development to determine the stopping point of the training process. Although there is no general formula for portioning the sample data, several factors should be considered during the division of the data, such as the type of data and sample size.

After the data cleaning, 75 percent of data were used for training the model and 25 percent of the data were used to test and validate the model. This has been adopted by many researchers (Jiang et al., 2014; Bai et al., 2015; Fan and Gurmu, 2015). During the training and learning process, weights and biases were adjusted automatically in the hidden layers (Amita et al., 2015). The input data, X1, X2 X3 X4 and X5, were applied as input data after the training process. The output was

connection lines and their weights, neurons hidden layers, and the input layer, as indicated in Figure 3.9.



**Figure 3.9:** Artificial Neural Network Model

$TT_{sec}$  is the link travel time,

$X_1$  is the traffic states (Peak hours and off-hour are the nominal data), which are given a value of 1 and 0 for peak hours and off-peak hours, respectively,

$X_2$  is the bus waiting time at the bus stops,

$X_3$  is the delay time at the intersections,

$X_4$  is the link travel distance,

$X_5$  is the traffic volume,

$W_{ij}$  is the synaptic weights connecting the  $i$ th input to the  $j$ th neuron which is represented by black numbers,

$b_j$  is bias value or error term which is presented by blue numbers.

The final output of this model is to link travel time. The prediction results were evaluated in terms of prediction accuracy using three measures: the MAE, the MAPE, and the RMSE.

### **3.4.7 Dynamic Model Descriptions**

The dynamic model consists of two main components: the first component is the ANN model estimating the baseline bus travel times in each route link; the second component is the Kalman filtering dynamic algorithm; the output from first component has been adjusted to next link travel. The rate of change travel time in the first link is not the same as the second link; meaning that the system is dynamic. Therefore, to address this phenomenon, the dynamic model has been introduced to describe the relationship between input and output.

The travel time for the first link is not correct, rather it is accompanied by random errors (or uncertainty). These errors come from the estimated model (ANN) known as Estimates Noise. Likewise, the dynamic model (Kalman Filter) is also associated with some errors (or uncertainty) called a Process Noise caused during the prediction of next link travel time. The sum of Measurement Noise and the Process Noise is known as extrapolated estimate uncertainty (variance) transport system. To address precisely next link travel time, Kalman Filter dynamic algorithm has been introduced to predict travel time, which is widely applied to predict urban dynamic travel time (Fan and Gurmu, 2015; Bai et al., 2015; Jiang et al., 2014)

The next link travel time has been reckoned by applying Kalman Filter dynamic algorithm using current estimated travel time from Artificial Neural

Network and previous link travel time or initial link travel time obtained from the earlier stage.

### 3.4.7.1 Kalman Filter Dynamic Algorithm

#### Initial stage

- Previous process error is initialized ( $F$ ) in the previous link ( $X_{k-1}$ )
- Estimate error is initialized (standard deviation  $\delta$ ) in the previous link( $U_{k-1}$ )
- Estimate travel time of current link is initialized ( $T_{1-0}$ )
- Estimate error is initialized through standard deviation ( $V$ ) in the current link( $U$ )
- The extrapolated estimate uncertainty ( $P_{0-1}$ ), as indicated in equation 3.4.7
- Predicted travel time in the next link ( $T_{1-1}$ )

$$P_{1-0} = \delta^2 + F \quad 3.4.7$$

where,

$P_{1-0}$  is a extrapolation error covariance,

$\delta^2$  is a initial variance for the previous link,and

$F$  is a initial Previous process error for the previous link

$$KG_0 = \frac{\delta^2 + F}{(\delta^2 + F) + V} \quad 3.4.8$$

where,

$KG_0$  is initial Kalman Filter Gain,

$\delta^2$  is a initial variance for the previous link,

$F$  is a initial Previous process error for the previous link ,and

$V$  is a initial estimate error for the current link.



**First stage**

$$T_{1-1} = T_{1-0} + KG_0 (T_{1-1} + T_{1-0}) \quad 3.4.9$$

where,

$T_{1-1}$  is the next link travel time from ANN-KF model( $X_{k-1}$ )

$T_{1-0}$  is estimated travel time from ANN model from current link ( $X_k$ )

$KG_0$  is the Kalman Filter Gain from previous link ( $X_{k-1}$ )

**New Estimate Error**

$$P_{1-1} = (1 - KG_0)P_{1-0} \quad 3.4.10$$

Where,

$P_{1-1}$  is a new extrapolation error covariance in the current link ( $X_k$ ),

$KG_0$  is the Kalman Filter Gain from previous link ( $X_{k-1}$ ),and

$P_{1-0}$  is a extrapolation error covariance from the previous link ( $X_{k-1}$ ),

**Second Stage (The next iterations)**

Current Filter Gain as in equation 3.4.11

$$KG_1 = \frac{(1-KG_0)P_{1-0}+F}{((1-KG_0)P_{1-0}+F)+V} \quad 3.4.11$$

Next link travel time as in equation 3.4.12

$$T_{2-2} = T_{1-1} + KG_1(T_{2-2} - T_{1-1}) \quad 3.4.12$$

New Estimate Error as in equation 3.4.13

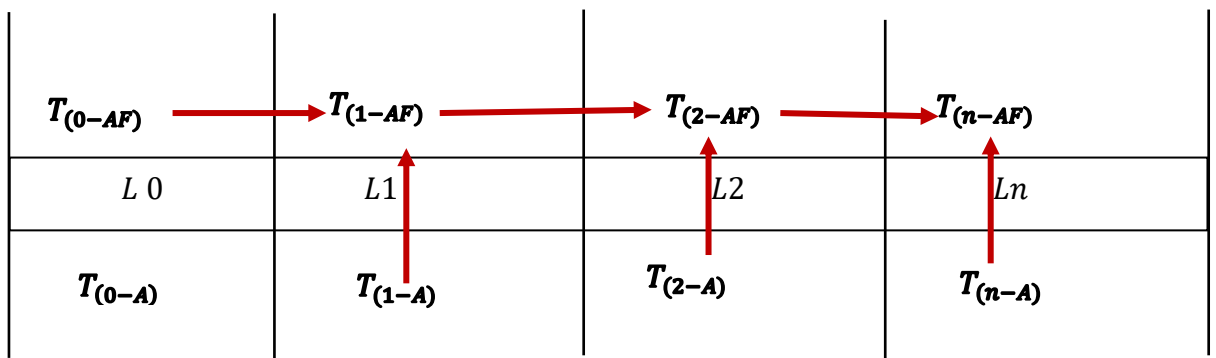
$$P_{2-2} = (1 - KG_1)P_{1-1}$$

3.4.13

**ANN-KF Dynamic algorithm Demonstration :**

- Previous process error initialized (F) in the previous link ( $X_{k-1}$ ) is 0.0001
- Estimate error initialized (standard deviation R) ( $B_{00}$ ) in the previous link( $U_{k-1}$ ) was 0.001
- Current link is initialized ( $T_{1-0}$ ) is 30
- Estimate error initialized through standard deviation (V) in the current link(U) is 100

Figure 3.14 represents the number of links from  $L_0$  to  $L_n$  with current baseline time in each link from  $T_{(0-A)}$  to  $T_{(n-A)}$  . The Kalman Filter dynamic algorithm applied as illustrated in a Equations 3.14 (a), (b) and (c) to predict next link travel time  $T_{(0-AF)}$  to  $T_{(n-AF)}$  which determined by Kalman Filter Gain (KG).



**Figure 3.10:** ANN-KF model application

L=Road link

$T_{(0-A)}$  = Initial link travel time (ANN model)

$T_{(1-AF)}$  = Future link travel time (ANN-KF Model)

$$L1; T_{(1-AF)} = T_{(1-A)+KG_0} (T_{(1-A)} - T_{(0-A)}) \quad 3.4.14a$$

$$L2; T_{(2-AF)} = T_{(2-A)+KG_1} (T_{(2-A)} - T_{(1-A)}) \quad 3.4.14b$$

$$Ln; T_{(n-AF)} = T_{(n-A)+KG_{n-1}} (T_{(n-A)} - T_{(n-1-A)}) \quad 3.4.14c$$

### 3.4.7.2 Model Performance

#### *Correlation Coefficient (r)*

A correlation between the variables indicates that as one variable changes in value, the other variable tends to change in a specific direction. It is a measure of how well a model can describe the relationship between the observed link travel time and predicted link travel time (Kumar et al., 2017). The quantity  $r$ , called the linear correlation coefficient, measures the strength and the direction of a linear relationship between two variables. The value of  $r$  ranges from -1 to +1. The + and – signs are used for positive linear correlations and negative linear correlations, respectively. In this study, a scatterplot was used to check the relationship between pairs of observed link travel time against predicted travel time from the ANN model, and the ANN model against the ANN-KF model.

### 3.4.7.3 Model validation

Model validation is the process by which model output is compared to real-world observations (link travel time) to judge the accuracy of the model and determine if it corresponds with reality (Fan and Gurmu, 2015).

The model performance was measured by comparing a pure ANN with the integration of ANN and the Kalman Filter dynamic algorithm (ANN-KF). The ANN-KF and ANN models were evaluated using the RMSE and MAPE. The RMSE and MAPE determined the fitness or deviation of the model from the actual travel time observed in the field. The calculation of MAPE and RMSE is described in Equations 3.4.13 and 3.4.14, respectively.

$$MAPE = \frac{1}{n} \sum_{i=1}^n \left| \frac{TT_{ob} - TT_{ped}}{TT_{ob}} \right| \quad 3.4.13$$

$$RMSE = \sqrt{\frac{1}{n} \sum_{i=1}^n \left| \frac{TT_{ob} - TT_{ped}}{TT_{ob}} \right|^2} \quad 3.4.14$$

The model which scored a small error was considered a suitable model for predicting urban travel time under heterogeneous traffic flow conditions, particularly in Dar es Salaam city

### **3.5. Establishment of Travel Time Reliability**

#### **3.5.1 The Concept of Travel Time Reliability**

The application of travel time reliability is based on the perspective of the operators and users. Users focus on how the variability of travel time is experienced, while operators focus on the quality of the road network (Bhouri et al., 2016). The diversity and geographical spread of socio-economic activities in cities of developing countries have caused travelers to rely primarily on transport services. The quality of accessibility to transport services depends primarily on travel time reliability. Travel time reliability is a valuable tool for evaluating transport service quality, operating costs, and system efficiency.

### **3.5.2 Reliability Definitions**

Travel time reliability relates to how travel times for a given trip time perform over time. It is a measure of the amount of delay time users experience in the transportation system at a given time (Lyman and Bertini, 2008). Measures of travel time reliability attempt to quantify the variability in travel times across different days and months, and the variability across different times of the day (Vanderval et al., 2014). Furthermore, reliability is the measure of the extent to which external events influence travel times. The impact of the external factors have great influence on congestion level, road infrastructures, and trip variability (FHWA, 2010). Taylor and Susilawati (2012) argue that travel time reliability is the ability of the route to provide transport service under given environmental and operational conditions at a stated time. Therefore, factors, such as time of day and the nature of traffic, have a more significant influence on urban travel time.

### **3.5.3 Analysis of Travel Time Reliability**

There are two common methods (statistic range and buffer time) used by many researchers to analyze urban travel time reliability (Chien and Liu, 2012; Bhourri et al., 2016; Lu, 2017). These methods are discussed in the following sections.

### **3.5.4 Statistical Range Methods**

Travel time reliability was analyzed using different techniques, such as standard deviation, coefficient of variation, and the 95th percentile travel time. However, the limitation of applying these techniques is that the interpretation and implementation may not be straightforward for non-experts, and as a result, it might be a less-effective communication tool.

### 3.5.4.1 Standard Deviation (STD)

The standard deviation (STD) is very useful in situations where there is a need to look at travel time variability around an average value. The greater the values of standard deviation, the more the spread in travel time variation, the result of which is less reliability (Guessous et al., 2014). STD was computed using Equation 4.2.1.

$$STD = \sqrt{\frac{1}{n-1} \sum_{i=1}^n (TT - M)^2} \quad 4.2.1$$

where,

*STD* is the standard deviation,

*n* is the number of trips observed,

*TT* is a travel time observation, and

*M* is the mean travel time.

### 3.5.4.2 Coefficient of Variation (CV)

The coefficient of variation (CV) is a ratio of the STD over the mean travel time, as shown in Equation 3.5.2. It represents the percentage of the travel time variation based on mean travel time.

$$CV = \frac{STD}{M} \quad 3.5.2$$

where,

*CV* is the coefficient of variation,

*STD* is the standard deviation, and

*M* is the mean travel time

### 3.5.4.3 95<sup>th</sup> Percentile Travel Time

Travel time reliability can be determined using percentile travel time, such as the 95<sup>th</sup> percentile. The 95<sup>th</sup> percentile of travel time is the estimation of travel time that 95 percent of the sample travel times experienced in the link. This is the difference between the mean and the 95<sup>th</sup> percentile travel time. The 95<sup>th</sup> percentile is estimated based on the bad delays travellers experienced in the route travel (Lu, 2017). These bad delays may be caused by traffic congestion, weather conditions, traffic control, and road incidents (Kuang et al., 2013). The 90<sup>th</sup> or 95<sup>th</sup> percentile travel times were reported in minutes in order to be easily understood by commuters in their daily trips.

### 3.5.5 Buffer Travel Time

Buffer time (BT) is the extra time travelers add to the in-vehicle time, including waiting time at the bus stops and the intersections (Russell, 2014). It explains the spare time to be added on an average trip, based on variations. Travelers may consider this as a high probability of arriving on time, as indicated in Equation 3.5.3. The higher the value of travel time variation, the less travel time reliability (Bharti et al., 2018). Furthermore, the high skew of the normal distribution curve indicates the stability of route travel times. Buffer travel time is calculated using Equation 3.5.3

$$Bt = tt_{95} - tt_{50} \quad 3.5.3$$

where,

$Bt$  is the additional time above the average travel time (  $tt_{50}$  ),

$tt_{95}$  is the 95th percentile travel time, and

$tt_{50}$  is the average travel time

### 3.5.5.1 Buffer Index

Buffer Index is the difference between the 95th percentile travel time and the average travel time, normalized by the average travel time. Buffer Index is calculated using Equation 3.5.4

$$BI = \frac{tt_{95} - tt_{50}}{tt_{50}} \quad 3.5.4$$

where

$Bi$  is the buffer index time,

$tt_{95}$  is the 95 per cent of sample travel times, and

$tt_{50}$  is the 50 percent of sample travel times.

### 3.5.5.2 Planning Time Index (PTI)

Planning time (PT) is the reasonable travel time that passengers use to be sure of arriving at their destination on time. It differs from the Buffer time index by including typical delay, as well as unexpected delay in in-vehicle travel time. For instance, a planning time index of 1.3 implies that passengers should add 30 percent to the average planning time to ensure on-time arrival. It gives the total time needed to plan for a 95 percent on-time arrival, compared to reasonable travel time. The planning time index (PTI) is computed as the 95<sup>th</sup> percentile travel time ( $TT_{95}$ ) divided by free-flow travel time ( $TT_f$ ), as shown in Equation 3.5.5.

$$PTI = \frac{tt_{95}}{tt_f} \quad 3.5.5$$



The 95-percentile value of travel time is considered as a reference value for the BI and PTI indicators, because they take into account extreme travel time delays compared to standard deviation.

Several previous studies indicate that travel time reliability can be estimated using statistical data and buffer time. (Bhourri et al., 2016; FDOT, 2016; FHWA, 2010; Chen et al., 2009). These methods are very simple and flexible to estimate travel reliability using various ranges of statistical data (Li et al., 2016). Therefore, this research applied statistics and buffer methods to estimate travel time reliability by considering the route travel time on the five main routes, including in-vehicle travel time, waiting at the bus stops, and waiting time at the intersections. This study also took into account the standard deviation, coefficients of variation, 95<sup>th</sup> percentile travel time buffer, and planning time on the five main routes in Dar es Salaam.

### **3.5.6 Data Used**

The travel time data were collected on the five main routes: Mbagala-Kariakoo (via Kilwa Road), Pugu-Kariakoo (via Nyerere and Uhuru Roads), Mbezi-Kariakoo (via Morogoro, Mandela, and Uhuru Roads), Tegeta-Kariakoo (via Bagamoyo, Ali Hassan Mwinyi and United Nation Road), and Kawe-Kariakoo (via Old Bagamoyo and Kawawa Roads). The travel time data were collected over five weekdays (Monday, Tuesday, Wednesday, Thursday, and Friday). Weekends were excluded in the sample since most people stay at home on Saturdays and Sundays, resulting in very low traffic flow in the city.

The surveys conducted between October 2018 and January 2019 managed to collect data in twenty-eight (28) trips per day. In other words, data was collected in fourteen (14) trips per day per direction. The survey period was 6:00 to 19:00 hours,

and was divided into two groups, off-peak hours and peak hours. For the inbound directions, peak hours were from 6:00 to 11:00 hours, and off-peak hours were from 11:00 to 19:00 hours. For the outbound directions, off-peak hours were from 6:00 to 14:00 hours, and peak hours were from 14:00 to 19:00 hours. During this period, no major weather issues were reported (i.e., rains or floods) that might have affected the travel time. Travel time data were collected for three weekdays, each hour on the five main routes in both directions (inbound and outbound), for a 14-hour duration. Weekend days were excluded. This methodology was used to ensure a sufficient sample size was obtained.

The sample size per route was obtained by the multiplication of survey time, number of directions, survey days, and number of links, as indicated in Table 3.10.

**Table 3.10: Survey Links and Time**

<b>Corridors</b>	<b>Survey Time</b>	<b>Directions</b>	<b>Survey Days</b>	<b>Links</b>	<b>Total Trips</b>
Tegeta-Kariakoo	14	2	3	5	420
Mbezi-Kariakoo	14	2	3	3	252
Pugu-Kariakoo	14	2	3	3	252
Mbagala-Kariakoo	14	2	3	2	168
Kawe-Kariakoo	14	2	3	3	252
Total Number of the trips					1344

The survey time period was 6:00 to 19:00 hours for all five main routes. Data collected included: travel time, delay time at the intersections, and bus waiting time at the bus stops, as shown in Table 3.11. Commuter buses (Daladala) operating along these routes were used as road sensors for traffic data collection.

**Table 3.11:** The Main Feature in the Five Corridors

Corridors	Link Name	Link Length (Km)	Bus Stops	Intersections
Tegeta-Kariakoo	Tegeta-Africana	5.5	8	2
	Africana - Mwenge	7.2	9	4
	Mwenge -Victoria	3.4	6	2
	Victoria - Mbyuni	2.4	2	2
	Mbuyuni - Kariakoo	6.7	7	5
Mbezi-Kariakoo	Mbezi - Ubungo	12.5	12	2
	Ubungo- Buguruni	7.5	11	3
	Buguruni-Kariakoo	3.6	7	2
Pugu-Kariakoo	Pugu-Aiport	11.3	15	1
	Aiport-Buguruni	7.5	5	4
	Buguruni-Kariakoo	3.6	8	2
Mbagala-Kariakoo	Mbagala-Uhasibu	7.0	10	2
	Uhasibu-Kariakoo	5.0	10	2
Kawe - Kariakoo	Kawe- Morocco	7.2	11	2
	Morocco-Magomeni	3.8	6	4
	Magomeni-Kariakoo	3.2	4	2

The data were analyzed using XLSTAT software, which is powerful and flexible tool that can be integrated with Microsoft Excel The software was applied to analyze travel time reliability on the five corridors. Route travel time, waiting time at the bus stops, and delay time at the intersections were used to estimate travel time reliability.

### 3.5.6.1 Determine Travel Time Reliability

Route travel time reliability shows the relation between high delay time in a day and normal delay time that passenger's experience. Several researchers have used the STD, 95th percentile, CV, buffer time, and planning time to measure travel time reliability (Bharti et al., 2018; Bhourri et al., 2016; FHWA, 2010). Therefore, this

study applied the aforementioned techniques to estimate reliability of route travel, waiting time at the bus stops, and delay time at intersections on the five study corridors.

Route reliability was analyzed using buffer time and planning time to determine reliability during the off-peak and peak hours, in both directions. Buffer time (BT) is the extra time users add to the average travel time to ensure on-time arrival, with 95 percent confidence, while taking into account the existing travel time situation. This study also determined the extra time needed by passengers to be added to the average travel time to ensure they arrive at their destination on time when traveling the five main corridors.

The buffer time index shows the ratio to be applied to the normal travel time to ensure passengers arrive on time. In contrast, the planning time index represents how much total time a traveler should allow to ensure on-time arrival.

Planning time (PT) is the total time needed to ensure travelers arrive on time, with confidence of 95%, compared to free-flow travel time. The planning time index (PTI) is established by applying the 95th percentile travel time (TT95) divided by free-flow travel time (TTfree-flow).

### **3.6 Delay Variation Distribution at the Intersection**

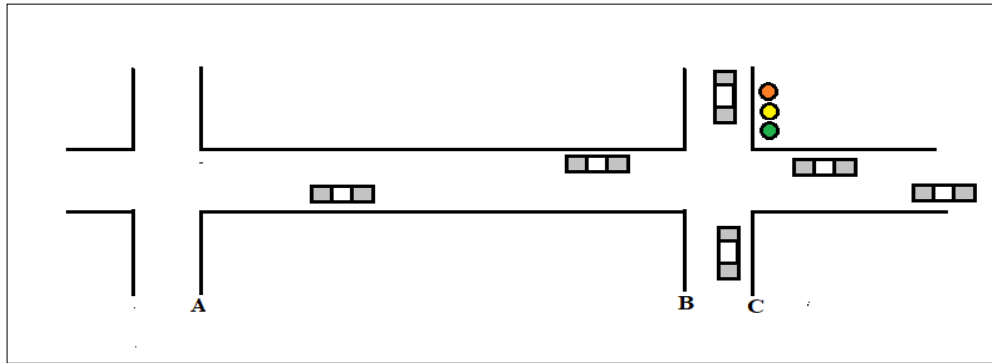
#### **3.6.1 Introduction**

The ability to quantify delay variation at intersections is a very crucial component in travel time prediction. Accurate travel time prediction is essential for road users, transport operators, engineers, transport planners, and signal control design. The random fluctuation and interruption caused by signal control at an intersection causes

the analysis of delay time at the junction to be complex. Researchers are applying several techniques to determine delay time variation at intersections. These techniques show reliable results for delay time variation, especially for homogenous traffic flow conditions (Chen et al., 2017). However, no studies have investigated the delay time distribution at intersections with mixed traffic flow in developing countries. This section is focuses on developing delay time distribution under heterogeneous traffic flow conditions at intersections in the City of Dar es Salaam.

### **3.6.2 The Concept of Modeling Delay Variability at Intersections**

Most of the models developed in previous studies focused on predicting average delay variation (Olszewski, 1993; TRB, 2000; Chen et al., 2017). These models investigated the delay distribution based on the initial queue and the number of vehicles arriving at the intersections, with the assumption that queues and the number of arrivals follow a certain distribution, such as the Poisson distribution (Olszewski, 1993). However, delay variation is an important parameter that is used in designing and improving the level of service (LOS) at intersections. The concept of intersection delay can be described as shown in Figure 3.15. The intersections in this study are described as the distance from point B to point C. Intersection delay time refers to the moment a vehicle enters at point B to the moment it leaves at point C (see Figure 3.11).



**Figure 3.11:** Schematic diagram of traffic flow at the intersection

Delay times at the intersections are calculated using Equation 3.6.1.

$$TT = t_{dt} - t_{at} \quad 3.6.1$$

where,

$TT$  is delay time at the intersection,

$t_{at}$  is the arrival time at the intersection, and

$t_{dt}$  is the moment vehicle pass at point C.

The travel time experienced by a vehicle in a given link (point A to point C, Figure 3.14) is composed of running time and delay time, as shown in Equation 3.6.2.

$$TT_{it} = tt_{fi} + tt_{di} \quad 3.6.2$$

where,

$TT_{it}$  is the travel time a vehicle experienced in the link "i" at a given time "t",

$tt_{fi}$  is the vehicle running time that a vehicle experienced in link  $I$ , and

$tt_{di}$  is the delay time a vehicle experienced at the intersection in the link  $i$ .

Furthermore,  $tt_{fi}$  is the running time and it is determined as indicated in equation 3.6.3.

$$tt_{fi} = \frac{L_i}{V_i} \quad 3.6.3$$

where,

$tt_{fi}$  is the link running time,

$L_i$  is the link length, and

$V_i$  is link speed.

In practice, the running time vehicles experience in the link consist of a degree of fluctuation, which is caused by driving behavior, speed limits, bus stops, pedestrian signs bumps, and roadside parking. However, delays due to signal control and initial queues constitute a large part of link travel time, which is the focus of this section. The delay time that a vehicle experiences at an intersection is the moment the vehicle enters at point B and the moment a vehicle leaves at point C (see Figure 3.14). The factors that influence intersection delay time are traffic light control, presence of a queue at the intersection, random flow of traffic, and traffic police control.

In reality, it is expected that the delay which vehicles experience at intersections should be less than or equal to the red phase time plus the green phase time, if the system is under saturation conditions (Chen et al., 2017). Some vehicles may pass without waiting, while others may wait for more than two cycles to cross point B to point C. Hence, the average delay that vehicles experience from B to C can be determined based on the delay time distribution (Olszewski, 1993; Chen et al., 2017). Furthermore, many researchers argue that the primary cause of delay time at

intersections are traffic control, traffic overflow, and random traffic flow (Fu and Hellinga, 2000; Zheng et al., 2015; Chen et al., 2017).

It is understood that predicting delay variation at intersections requires an accurate estimation of both the running time and the intersection delay variability. Delays at intersections are extremely uncertain, especially along urban arterials under signal control. The focus of this study was to determine delay variation at the intersections in the study area. Vehicle delay at a signalized intersection depends on the arrivals and departures, the length of the red and green phases, and the initial queue. The queue length is a step function that increases by one at the arrival of a vehicle and decreases by one at the departure of a vehicle, in one cycle. If the expected value is considered as being a queue length, then the queue length becomes a continuous function of time. The expectation value of the queue length can be derived from the probability function of queue length proposed by Viti et al., (2010).

### **3.6.2.1 Intersection Delay Time Model**

The delay variation function was derived for two scenarios: off-peak hours and peak hours. For the off-peak scenario, it was assumed that at the beginning of the red phase, at time  $(t) = 0$ , no initial queue existed at the stop line of the intersection, and that the beginning of the red phase ( $Tr$ ) and the green phase ( $Tg$ ) was not fully saturated, on average. The queue length increased proportionally to the red time phase ( $Tr$ ) and decreased proportionally to the green time phase ( $Tg$ ). The average arrival rate is equal to  $q$  and remains constant during the evaluation period. The delay as a function of time at the stop line of the intersection can be derived as proposed by Zheng and Van Zuylen (2010), and described by Equations 3.6.4a - 3.6.4b.



First step - no queue exists at the intersection

$$D_t = T_r + \frac{1}{s} - t \left( 1 + \frac{q}{s} \right), \text{ if } T_r \leq t \leq \frac{T_r + \frac{1}{s}}{1 - \frac{q}{s}} \quad 3.6.4a$$

$$\text{or } D_t = 0, \text{ if } t \geq \frac{T_r + \frac{1}{s}}{1 + \frac{q}{s}} \quad 3.6.4b$$

where,

$D_t$  is the delay time at the intersection,

$T_r$  is the red phase time,

$S$  is the saturation flow rate,

$t$  is the arrival, and

$q$  is the arrival flow rate,

In the second step, a queue exists at the intersection. Let us assume that an initial overflow queue exists at the start of the red phase and that the green phase is still long enough to handle all traffic. Then, the delay time can be derived as shown in Equations 3.6.4c and 4.3.4d.

$$D_{t/no} = T_r + \frac{n_o + 1}{s} - t \left( 1 + \frac{q}{s} \right), \text{ if } T_r \leq t \leq \frac{T_r + \frac{n_o + 1}{s}}{1 - \frac{q}{s}} \quad 3.6.4c$$

$$\text{or } D_t = 0, \text{ if } t \geq \frac{T_r + \frac{n_o + 1}{s}}{1 + \frac{q}{s}} \quad 3.6.4d$$

where,

$D_t$  is the delay time at the intersection,

$T_r$  is the red phase time,

$S$  is the saturation flow rate,

$t$  is the arrival, and

$q$  is the arrival flow rate,

$n_o$  is the initial queue at the intersection beginning of red phase time.

### 3.6.2.2 Determine Delay Time Variation at the Intersection

The maximum delay time is the total time a vehicle experienced at the intersection in each cycle, counted immediately after the effective green time started. It is equal to the red phase ( $T_r$ ) plus the time necessary to release the initial queue, and the departure time of the vehicle itself. The delay time decreases linearly until the end of the saturated green time and the delay is zero, as indicated in Figure 3.12.



**Figure 3.12:** Changing Delay Time at Intersection

The probability of the vehicle having a delay from  $D_{t_1}$  to  $D_{t_2}$  at the intersection is determined as shown in Equation 3.6.5.

$$P(D_{t_1} \leq X \leq D_{t_2}) = \int_{t_1}^{t_2} f(x) dx \quad 3.6.5$$

where,

$D_{t_1}$  is delay time at  $t_1$

$D_{t_2}$  is delay time at  $t_2$ , and

$x$  is the link distance from  $t_1$  to  $t_2$ .

### 3.6.2.3 Determine of Delay Time Variation

Delays that individual vehicles experience at intersections are usually subjected to large variation due to the randomness of traffic arrivals, and interruption caused by

traffic signal controls and traffic police. However, the majority previous analyses has only focused on average delay estimation, which alone cannot provide an accurate representation of changes in actual traffic conditions, unlike delay time variability at intersections. Chen et al., (2013) and Olszewski (1993) suggested a new method for evaluating delay at intersections through the application of probability distribution times to determine delay distribution and confidence intervals. This technique evaluates intersection performance to be more meaningful. Furthermore, TRB (2000) suggests that the reputable model is the one that can capture the total amount of variation distribution to determine LOS. However, the implementation of current models is still limited for urban road networks, especially in developing countries.

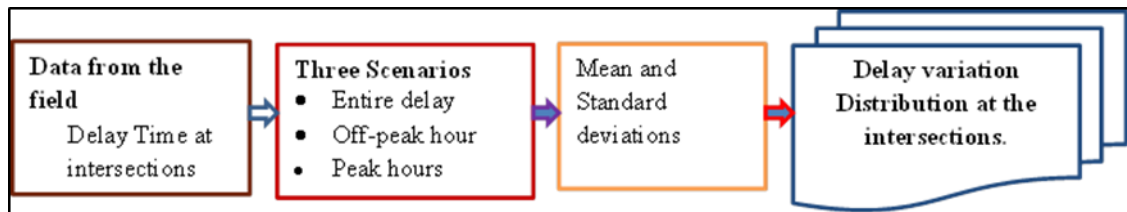
Most of the literatures have shown the evaluation of delay distribution at intersections based on traffic flow states (off-peak and peak) (Chen et al., 2013; Zheng and Van Zuylen, 2010; Fu and Hellinga, 2006; Olszewski, 1993). The evaluation of delay distribution at intersections on the five main corridors in Dar es Salaam city will inform planners of road bottlenecks in urban road network. Three scenarios were considered: the entire day delay distribution, peak hour delay distribution, and off-peak hour delay distribution.

The analysis of delay variation at the intersections was performed using a total of 674 samples of data collected from 41 junctions on the five main corridors. Data was collected on weekdays (Monday- Friday), as indicated in Table 3.12.

**Table 3.12:** Surveyed Intersections in Five Main Corridors

Corridor Name	Survey Time (hrs)	Number of Directions	Number Intersections	Samples collected
Tegeta-Kariakoo	14	2	15	246
Mbezi- Kariakoo	14	2	6	99
Pugu- Kariakoo	14	2	7	115
Mbagala- Kariakoo	14	2	6	99
Kawe - Kariakoo	14	2	7	115
Total Number			41	674

The data collected from the field was organized into three scenarios: the entire delay (inbound and outbound), off-peak hour delay (inbound and outbound), and peak hour delay (inbound), as indicated in Figure 3.13.

**Figure 3.13:** Delay Variation Distribution Analyses

#### 3.6.2.4 Determine Normal Delay Distribution

Accurate estimation of vehicle delay is difficult because of the randomness of traffic flow and large number of factors affecting intersection capacity. Existing delay models simplify the real traffic conditions and provide only approximate point estimates of average delay, whereas its variability should also be of interest (Chen et al., 2013). A stochastic model was used to study the changing probability distribution of delay at intersection has shown positive improvement to most of road users, such as transport planners and operators (Chen et al., 2013; Fu and Hellings, 2006; Olszewski, 1993). The model is based on sequential calculation of queue length probabilities with any type of arrival process. Delay probability distribution was

investigated for different degrees of saturation, arrival types and control conditions (Viti et al., 2010). The variance of delay increases rapidly with degree of saturation and is inversely proportional to the approach capacity (Chen et al., 2017). Other parameters such as cycle time and saturation flow do not have a significant effect on delay distribution (Chen et al., 2013; TRB, 2000). Both the mean and variance of delay are sensitive to arrival process characteristics and increase with the variance of arrivals (Hellings, 2006; Olszewski, 1993). However, this study uses normal distribution to predict delay distribution under heterogeneous traffic flow conditions. The delay variation distribution was determined based on a function of average delay time, STD, and Z-value, as indicated in Equation 3.6.5

$$D(t) = f(\mu, \sigma, z) \quad 3.6.5$$

where,

$D(t)$  is the delay distribution at time  $t$ ,

$U$  is the average delay at time  $t$ ,

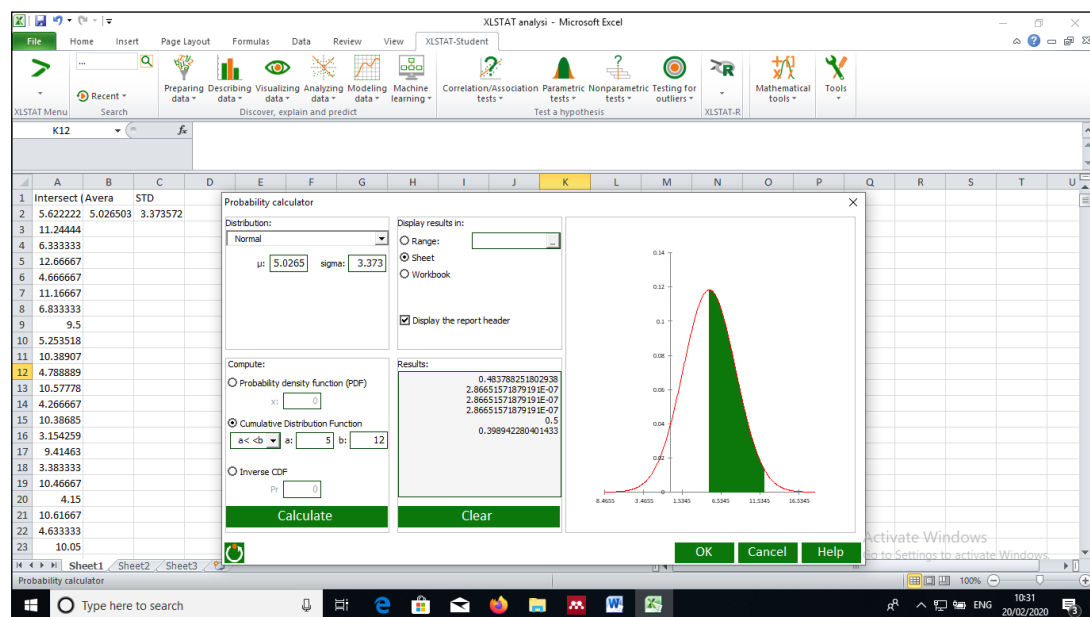
$\sigma$  is the standard deviation, and

$Z$  is the score that explains the value of an observation or data point is above or below the mean value of what is being observed or measured.

The data was edited and checked for their reliability, and outliers and unusual travel times from the corridors were removed and adjusted. The XLSTAT software was used to simulate delay variation distribution in all 41 intersections. XLSTAT is the statistical analysis add-in that offers a wide variety of functions to enhance analytical capabilities. It is compatible with all Excel versions, such as Microsoft

version 2003 to version 2016 (2011 and 2016 for Mac). Delay data from the 41 intersections was inserted as input data in the XLSTAT modeling data tools, with a distribution fitting dialog box.

The XLSTAT software was used to analyze delay variation under two scenarios: inbound direction and outbound direction. The software has the ability of analyzing delay variation in different time intervals at the intersections, as demonstrated in Figure 3.14.



**Figure 3.14:** XLSTAT software delay variation through distribution curve

The inbound and outbound delay variations were further classified into three scenarios: the entire delay, off-peak hours, and peak hours. This three-scenario analysis was conducted to gain more insight into delay variation at the intersections. This approach also considered the delay variation caused by traffic control and traffic police control at the intersections. The traffic flow at the intersections contained different sizes of vehicles, as well as different speeds, which make the prediction of delay variation at the intersections to be too complex.

Vehicle discharge during the green interval primarily depends on the queue status at the intersection. Whenever there was no queue at the intersections, vehicles were discharged immediately without waiting at the intersection and the delay became zero. Otherwise, the vehicle would wait until the discharge of the queue ahead of it. Delay variation was estimated each of the 41 intersections on the five main corridors in Dar es Salaam city for the three scenarios, entire delay, off-peak, and peak periods, while also taking into account signal and police control at the intersections.



## **CHAPTER 4 – RESEARCH FINDINGS AND DISCUSSION**

### **4.1 Introduction**

This Chapter discusses the output of developed Dynamic Travel Time Prediction model by comparing and combining existing models, such as the Multiple Linear regression model, Artificial Neural Network model, and the Kalman Filter algorithm, to obtain a suitable dynamic model. However, travelers and transport operators may not only be interested in route travel time, but also in route travel time reliability, which is also presented in this Chapter. Furthermore, transport engineers and planners are interested in knowing the behaviour of travel time variation at different parts of the urban road network, as well as the locations with considerable variations. To answer this, the study evaluates delay variation distribution on the five main corridors in Dar es Salaam city in Tanzania.

### **4.2 Development of the Dynamic Travel Time Model**

The dynamic travel time model was developed using data collected in Dar es Salaam city, using public buses operating on the five study corridors: Tegeta-Kariakoo, Kawe-Kariakoo, Mbezi Luisi- Kariakoo, Pugu-Kariakoo, and Mbagala-Kariakoo. The data collected on these corridors include the link travel time, waiting time at the intersections, link length, traffic volume, and traffic flow states (peak hours and off-peak hours). For analyses, the dependent and independent variables were established as indicated in Table 4.1.

**Table 4.1:** Travel Time Independent and Dependent Variables

<b>Independent Variables</b>	<b>Average (Inb)</b>	<b>Average (outb)</b>	<b>Units</b>
Link Length	6.0	6.0	Km
Waiting Time at intersections	6.0	5.5	Minutes
Waiting Time at bus stops	7.0	8.0	Minutes
Traffic states (Peak and off-peak)	0.5	0.5	Hours
Traffic Volume	1241	1173	No. of Veh/hr
<b>Dependent Variables</b>	<b>Average (Inb)</b>	<b>Average (outb)</b>	<b>Units</b>
Link Travel time	25	21	Minutes

#### 4.2.1 Similarities of Traffic Flow per Week

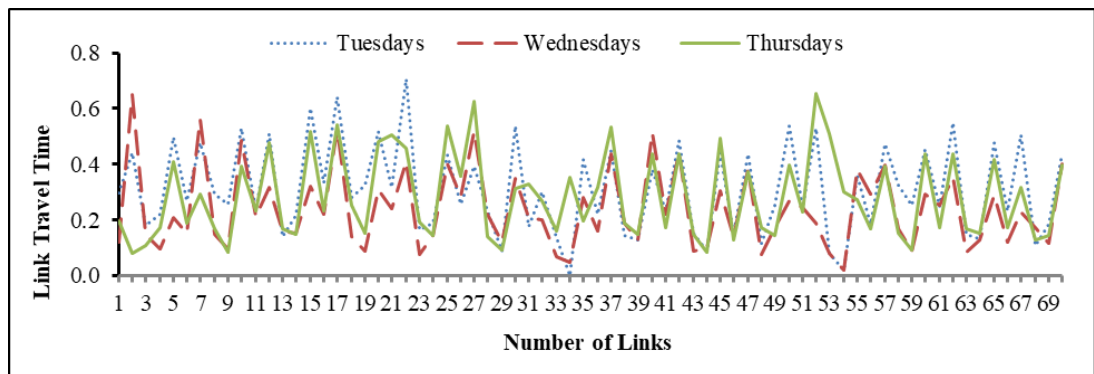
The data were analyzed and the reliability computed. Results reveal that the travel time mean and STD have similar values, as indicated in Table 4.2.

**Table 4.2:** Weekly Travel Time Descriptive Statistics

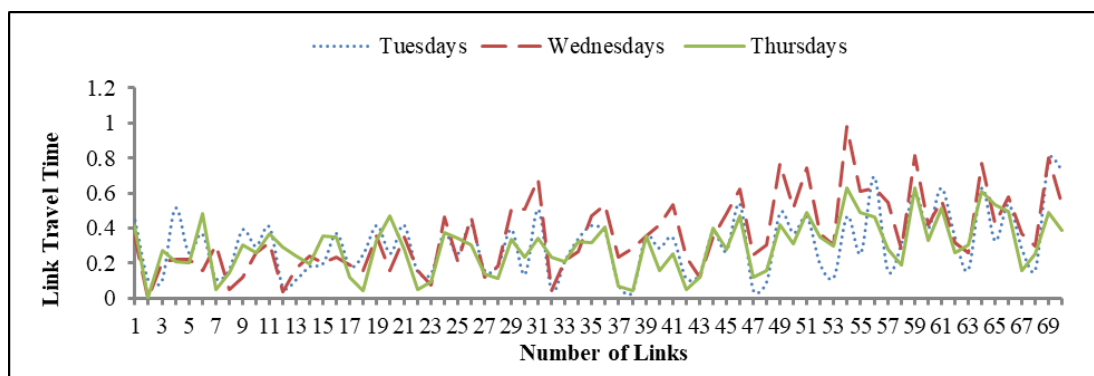
<b>Name of Days</b>	<b>Average (Min)</b>		<b>STD (Min.)</b>	
	Inbound	Outbound	Inbound	Outbound
<b>Monday</b>	22.3	20.9	8.8	8.4
<b>Tuesday</b>	21.6	21.0	9.0	8.2
<b>Wednesday</b>	20.8	21.9	9.1	8.5
<b>Thursday</b>	22.0	21.9	8.9	8.6
<b>Friday</b>	23.1	22.2	7.8	8.5

Figures 4.1 and 4.2 present travel time in each link for three weekdays (Tuesday, Wednesday, and Thursday) for the inbound and outbound directions, respectively. Travel time prediction has an association with the level of uncertainty, which depends upon the underlying variability of the data, as well as the sample. Time

variations for each link are a significant factor, since it shows how travel time varies during the weekdays. Travel time variations were observed between different lines, corresponding to different weekdays. As shown in Figures 4.1 and 4.2, travel time variation is relatively small during the weekdays. In this case, the data is considered as a precise sample size for model development.



**Figure 4.1:** Travel Time Variation Inbound Directions



**Figure 4.2:** Travel Time Variation Outbound Directions

## 4.2.2. Model Performance and Evolution

### 4.2.2.1 Comparison of MLR and ANN Models

The output from the MLR and ANN may not be applied directly to predict the next link travel time because the MLR and ANN models were built using historical data. The performance of the models were evaluated in terms of accurate urban travel time prediction, based on R squared, the MAPE, and RMSE, as indicated in Table 4.3.

**Table 4.3:** Comparison between MLR and ANN Models

Traffic States	Multiple Linear Regression Model				Artificial Neural Network Model		
	Variables	R <sup>2</sup>	MAPE	RMSE	R <sup>2</sup>	MAPE	RMSE
Inbound Direction	6	0.88	39.69	0.13	0.96	18.54	0.07
Outbound Direction	6	39.6 9	75.11	0.18	0.82	25.69	0.08
Morning Peak Hours (Inbound)	6	0.90	32.86	0.13	0.97	18.68	0.07
Evening Peak hours (Outbound)	6	0.84	50.89	0.20	0.98	15.50	0.07
Morning Off-peak (Outbound)	6	0.85	75.10	0.18	0.95	30.99	0.09
Evening Off-peak (Inbound)	6	0.80	44.03	0.13	0.96	21.23	0.08

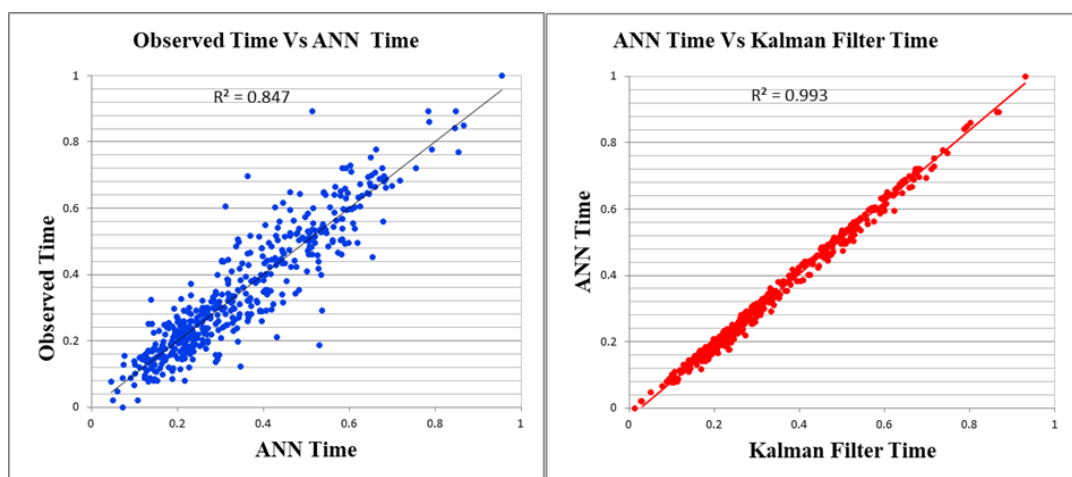
From Table 4.3, it can be observed that the MLR model has higher MAPE and RMSE values compared to the ANN model. This indicates that it has poor performance. The ANN model has high R square values compared to the MLR model, which reflects excellent performance, compared to the MLR model. Therefore, the ANN model was considered as a suitable model to be integrated with Kalman Filter algorithm to obtain future link travel time.

#### 4.2.2.2 Comparison of ANN and ANN-Kalman Filter (ANN-KF) Models

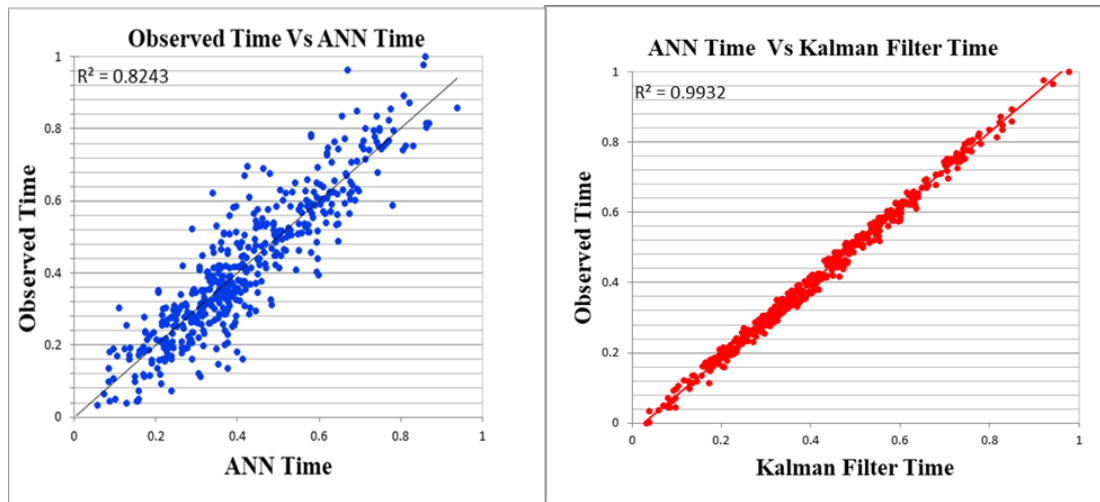
##### *Model correlation coefficient (r)*

After developing the ANN-KF model, it was necessary to evaluate its performance in terms of prediction accuracy. The prediction accuracy was assessed and compared with the ANN model employing R-square. From Figure 4.3(a), (b) and Figure 4.3(c), (d), it is shown that the R-square of the ANN model ranges from 82 to 84 percent, which means that over 82 percent of the dependent variable (observed urban travel time) was explained by the independent variable, which is the estimated urban travel time by ANN.

Furthermore, about 99 percent of the predicted travel time by ANN-KF Model explained travel time from the ANN Model, which implies that 99 percent of the expected travel time by the ANN-KF Model was well fitted in the ANN Model



**Figure 4.3 (a), (b):** ANN Inbound and Kalman Filter Inbound



**Figure 4.3 (c), (d): ANN Outbound and Kalman Filter Outbound**

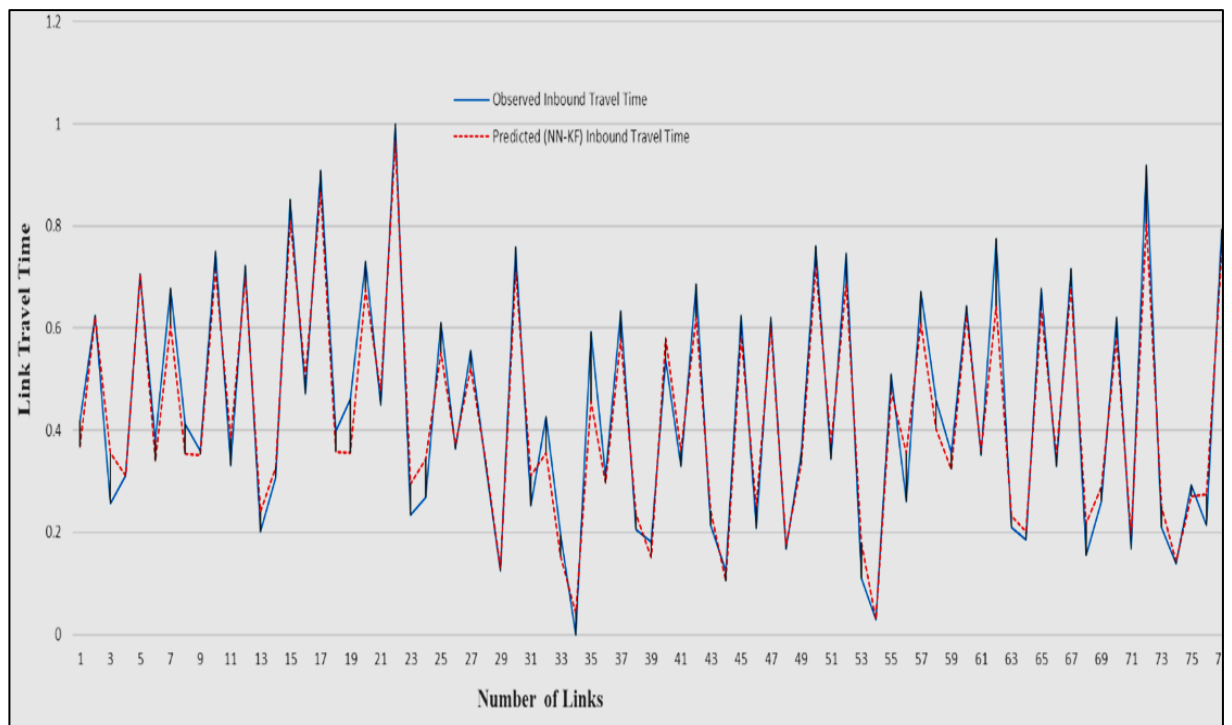
#### 4.2.2.3 Model Validation

Model validation is the process of determining whether the model accurately represents the behavior of the system (Zheng, 2011). Model validity should be evaluated by its operation, thus, by determining if the model output (link travel time prediction) against the actual data (link travel time data collected from the field). It is the process of comparing model prediction to an independent actual data from the field (Bai et al., 2015).

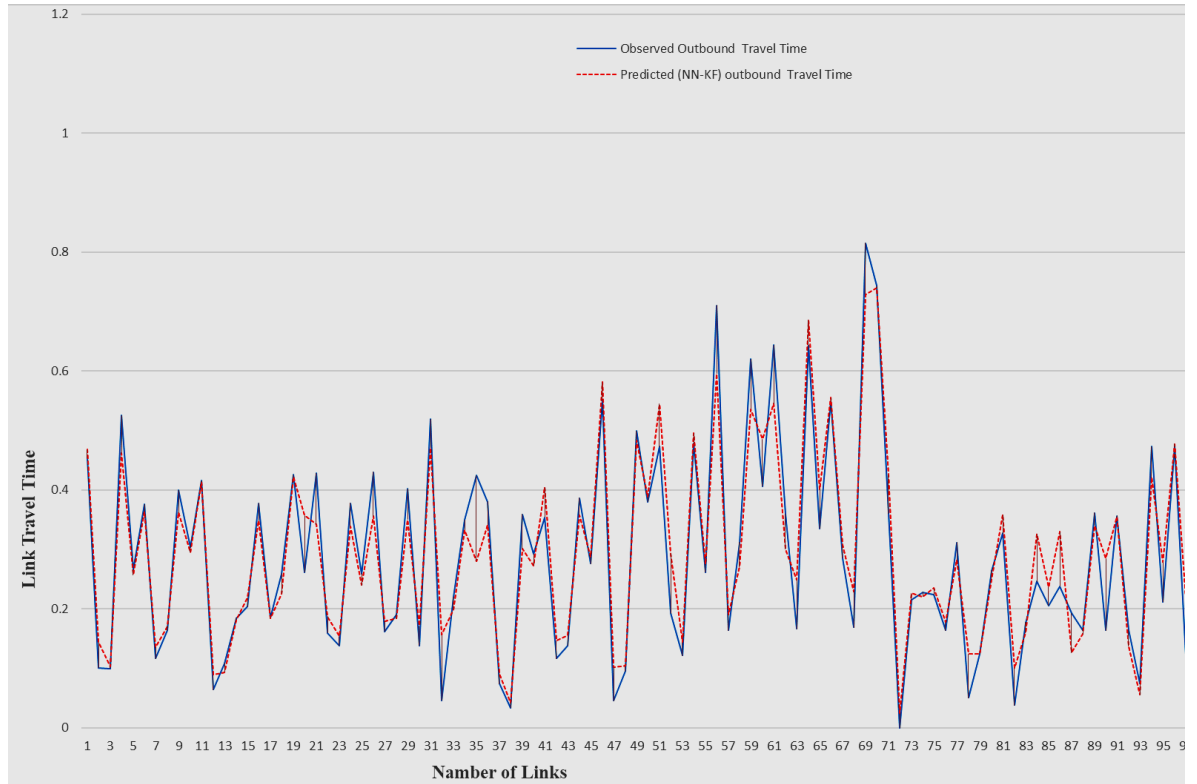
There are many statistic methods used to validate models. But, the most common methods used to validate models are graphical and numerical residual analysis methods (Bai et al., 2015; Zheng, 2011). The graphical residual analysis methods use caves, lines or bars to show the fitness or miss fit of graphs against the actual and simulated data (Fan and Gurmu, 2015). Therefore, the study used both graph and numerical methods to validate ANN-KF model.

### *The graphical method*

Figure 4.4 (a) and (b) show relationship between the predicted time from ANN-KF model and actual time from field, whereby dotted red lines, blue solid lines predict travel time, and actual travel time respectively. The results show small variations between predicted time and observed time, meaning that results from ANN-KF model represent reasonably the actual time.



**Figure 4.4 (a):** Comparison observed and predicted outbound travel time



**Figure 4.4 (b):** Comparison observed and predicted outbound travel time

### *Numerical Method*

The study used MAPE and RMSE to evaluate the relationship between actual and predicted time using Equations 4.2.1 and 4.2.2.

$$MAPE = \frac{1}{n} \sum_{i=1}^n \left| \frac{TT_{ob} - TT_{pred}}{TT_{ob}} \right| \quad 4.2.1$$

$$RMSE = \sqrt{\frac{1}{n} \sum_{i=1}^n (TT_{ob} - TT_{pred})^2} \quad 4.2.2$$

where

$TT_{ob}$  is the predicted travel time from ANN,

$TT_{pred}$  is the predicted bus travel time from ANN-KF model, and

$n$  is the number of bus trips observed in the main corridors.



**Table 4.4 (b) : Comparison of Prediction Errors for two Models**

	<b>ANN-KF Model</b>	
	<b>MAPE%</b>	<b>RMSE</b>
Inbound Direction	8.72	0.02
Outbound Direction	10.58	0.20
Morning Peak Hours (Inbound )	6.11	0.21
Evening Peak hours (Outbound)	5.24	0.22
Morning Off-peak(Outbound)	8.63	0.23
Evening Off-peak (Inbound)	7.14	0.02

The results shown on Table 4.4, the Mean Parentage Error(MPE) of ANN-KF model range from 15.50 to 30.99, while Root Mean Square Error (RMSE) range from 0.02 to 0.22 in both directions.

It can be concluded that, integration of the Artificial Neural Network model and Kalman Filter algorithm promise to be a reasonable model for predicting dynamic travel time in Dar es Salaam city.

### **4.3 Route Travel Time Reliability**

This section presents the analysis of travel time reliability in Dar es Salaam city on bus operation on the five main corridors, using link length, waiting time at the intersections, and waiting at the bus stops. The study applied standard deviation, coefficient of variation, buffer time, and planning time to compute travel time reliability using the data collected on the five main bus routes in Dar es Salaam.

The quality of urban transport services depends mainly on travel time reliability. Travel time reliability is affected by a number of factors, such as link length, delay time at the intersections, and waiting time at the bus stops. This study used travel time reliability as the dependent variable, and link length, delay time at the intersections, and waiting time at the intersections, as the independent variables, as indicated in Table 4.5. The XLSTAT software was applied to analyze route travel

time reliability based on standard deviation, 95 percentile travel time, buffer time, and planning time.

**Table 4. 5:** Travel Time Independent and Dependent Variables

<b>Independent Variables</b>	<b>Units</b>	<b>Dependent Variables</b>	<b>Units</b>
Link travel time	Minutes	Standard deviation	Minutes
Waiting time at intersections	Minutes	95th percentile	Minutes
Waiting time at bus stops	Minutes	Coefficient of variation	Ration
		Buffer time	Minutes
		Planning time	Minutes

#### 4.3.1 Day-to-day Travel Time Variability

Table 4.6 presents the average delay time, standard deviation at 95 percentile time, and coefficient of variation of all surveyed routes. The mean travel time ranged between 33.87 to 90.30 minutes for the inbound direction, and between 36.98 to 87.36 minutes for the outbound direction. The standard deviation ranged between 5.24 to 15.02 minutes for the inbound direction, and between 7.89 to 23.22 minutes for the outbound direction. The coefficient of variation (CV) ranged between 11 to 21 percent for the inbound direction, and between 13 to 27 percent for the outbound direction. Higher travel time variations were observed during off-peak hours, mainly for outbound direction, compared to the inbound directions, implying that the travel time for the off-peak period for the outbound directions are less reliable than the inbound directions. This indicates that travel time is unreliable during the off-peak hours, especially for the outbound direction. This unreliability results in a low quality of transport services.

**Table 4.6:** Average Travel Time and Standard Deviation at Route Levels

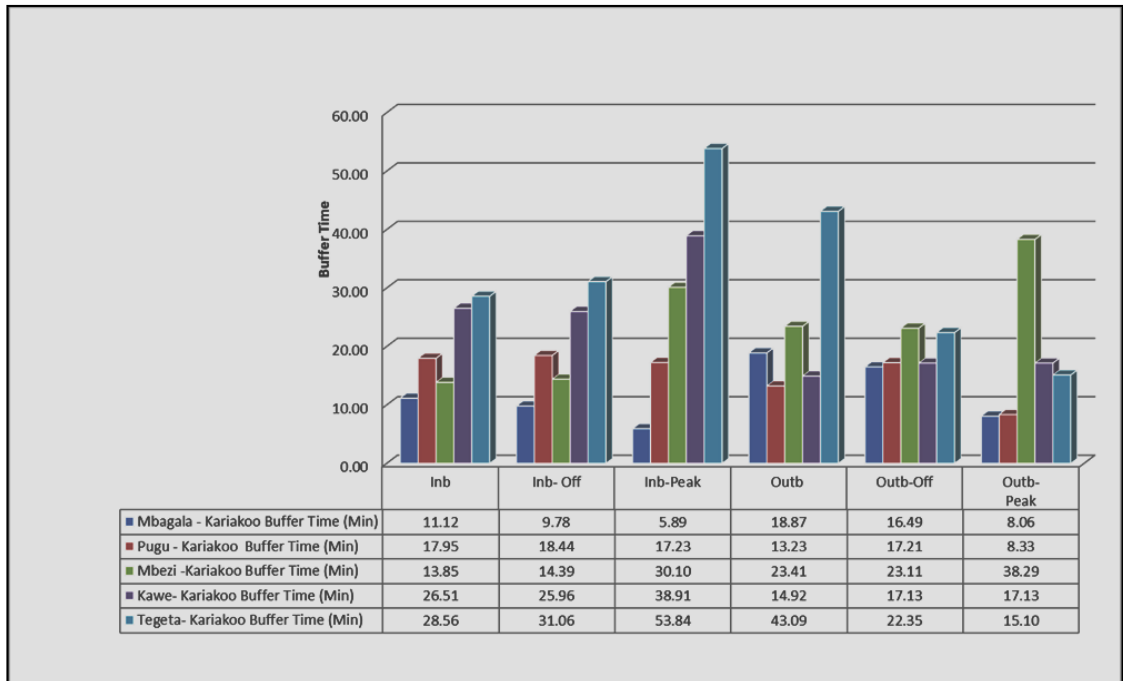
<b>Corridor</b>	<b>Parameters</b>	<b>Inbound Direction</b>	<b>Outbound-Direction</b>
Mbagala-Kariakoo	Mean (min)	33.87	36.98
	STD (Min)	5.24	7.89
	95th percentile (Min)	35.20	39.42

Corridor	Parameters	Inbound Direction	Outbound-Direction
	CV	0.15	0.21
Pugu - Kariakoo	Mean (min)	80.15	72.43
	STD (Min)	10.95	9.38
	95th percentile (Min)	97.20	85.66
	CV	0.14	0.13
Mbezi-Kariakoo	Mean (min)	79.05	81.03
	STD (Min)	8.44	11.53
	95th percentile (Min)	92.90	104.44
	CV	0.11	0.14
Kawe - Kariakoo	Mean (min)	64.05	67.32
	STD (Min)	13.25	9.69
	95th percentile (Min)	90.56	82.24
	CV	0.21	0.14
Tegeta - Kariakoo	Mean (min)	90.30	87.36
	STD (Min)	15.02	23.22
	95th percentile (Min)	118.87	130.45
	CV	0.17	0.27

#### 4.3.2 In-Vehicle Buffer Time

Figure 4.5 presents the in-vehicle Buffer time of all five surveyed routes, analyzed at 95 percent confidence. For the inbound (Inb) and outbound (Outb), the in-vehicle buffer time varies between 11.12 to 28.56 minutes and 13.23 to 43.09 minutes, respectively. During the inbound off-peak (Inb-off) and outbound off-peak (Out-off) time, the buffer time varies between 9.78 to 31.06 minutes and 16.49 to 23.11 minutes, respectively. Likewise, during the inbound peak hours (Inb-peak) and the outbound peak hours (Out-peak), the in-vehicle buffer time ranges from 5.89 to 53.84 minutes and 8.06 to 38.29 minutes, respectively. Higher buffer times were observed on the Tegeta-Kariakoo route for the inbound peak hours and outbound directions, particularly in-vehicle time, while a low value of buffer time was noted on the Mbagala-Kariakoo during inbound peak hours. It was found that the travel time reliability during peak hours is greatly affected by the route distance. For example,

travelers that use the Mbagala-Kariakoo route spend 33.87 and 36.98 minutes, on average, for the inbound and outbound directions. However, due to the travel time variation, they must reserve 11.2 and 18.87 minutes as extra time to overcome travel time variability.

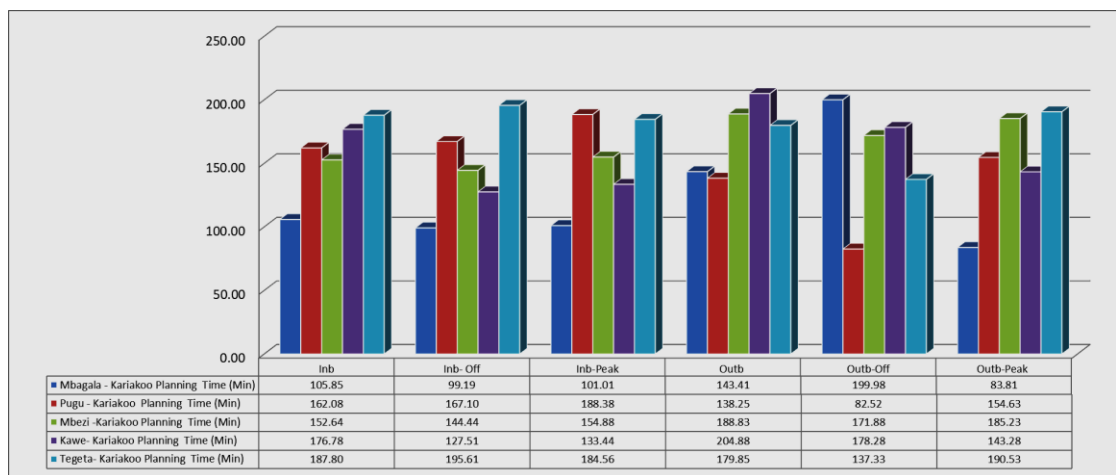


**Figure 4.5:** In-vehicle Buffer Time in Dar es Salaam City

### 4.3.3 In-Vehicle Planning Time

Figure 5.6 presents the in-vehicle planning time of all five surveyed routes. Higher planning times were observed for the Mbagala-Kariakoo route during outbound off-peak, Pugu-Kariakoo during inbound peak hours, Mbezi-Kariakoo during outbound peak hours, Kawe-Kariakoo during inbound off-peak, and Tegeta-Kariakoo during inbound peak hours. Also, the minimum planning time was observed for the Mbagala-Kariakoo route during outbound peak hours, Pugu-Kariakoo during outbound off-peak, Mbezi-Kariakoo during inbound off-peak, Kawe-Kariakoo during intbound off-peak hours, and Tegeta-Kariakoo during outbound off-peak

hours. Dar es Salaam commuters that want to travel from Tegeta to Kariakoo should spend 180.80 and 179.85 minutes for inbound and outbound, 195.61 and 137.33 minutes for off-peak inbound and outbound, and 194.56 and 190.53 minutes for peak hour inbound and outbound, respectively, to be able to reach their destination on time. The reason for the low value of planning time observed in the inbound direction, compared to the outbound direction, is that, most of the bus drivers drive at low speeds and spend a long time at the bus stops waiting for passengers.

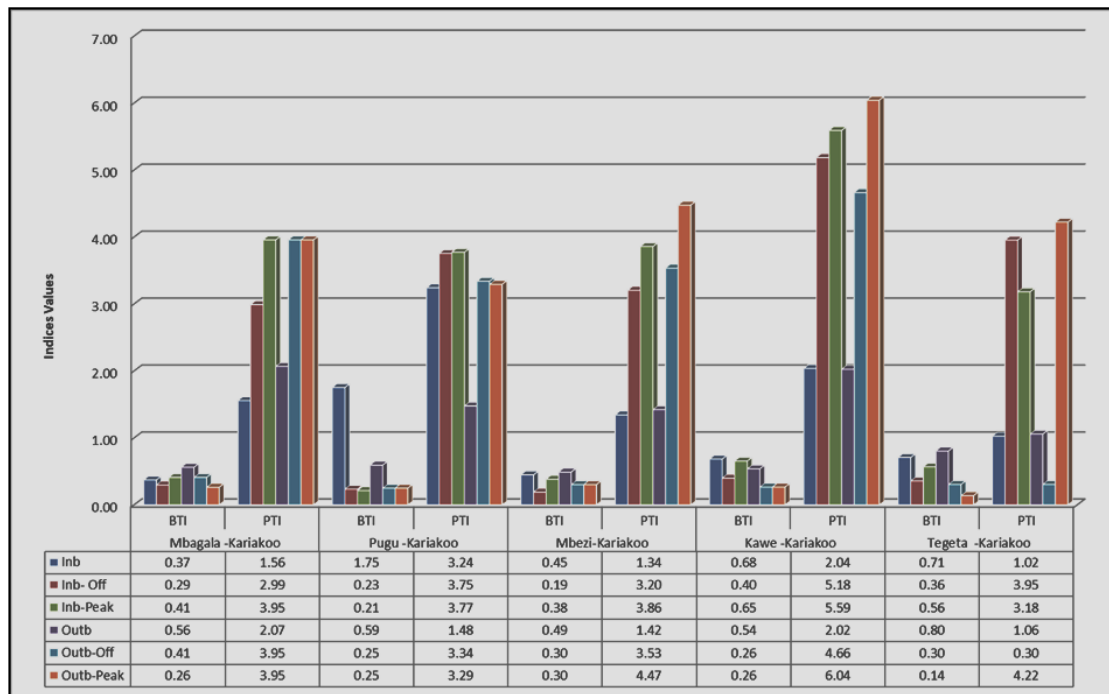


**Figure 4.6:** In-Vehicle Planning Time in Dar Es Salaam City

#### 4.3.4 Route Buffer Time Index and Planning Time Index

Figure 4.7 presents the In-vehicle Buffer Time Index (BTI) and the Planning Time Index (PTI) of the five surveyed routes. The BTI varies from 0.30 to 6.40, and the PTI varies from 0.14 to 0.80. Higher and lower PTI values were obtained in the Pugu-Kariakoo and Tegeta-Kariakoo. However, high and low BTI values were observed in Pugu-Kariakoo and Mbezi-Kariakoo. Furthermore, results showed that the Tegeta-Kariakoo route had a low PTI value, particularly the in-vehicle time compared to other routes. In contrast, Kawe-Kariakoo had a high value of PTI for the

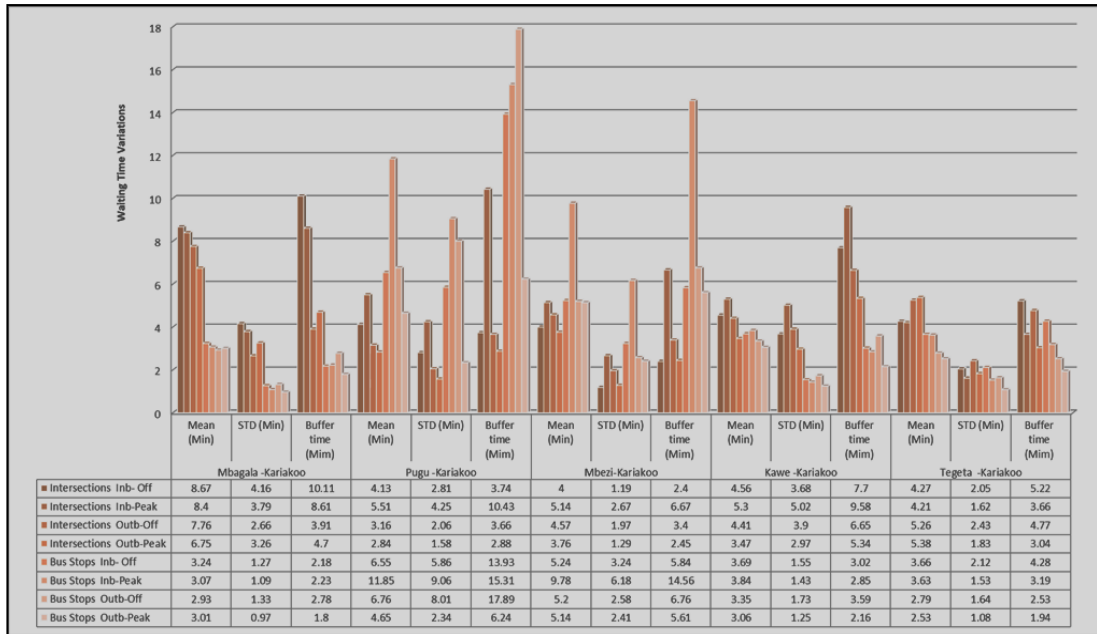
in-vehicle time compared to other routes. This implies that the Kawe-Kariakoo route was more congested than other routes because of the use of more private cars than public vehicles.



**Figure 4.7:** Buffer Time and Planning Time Index

### 4.3.5 Waiting Time Reliability at Bus Stops and Intersections

Figure 4.8 presents the mean time, standard deviation time, and buffer time at the bus stops and intersections. During the inbound peak hours (Inb-Peak) and outbound peak hours, the waiting time at the bus stops deviates from the mean waiting time by 1.62 to 5.02 minutes and 1.29 to 3.26 minutes, respectively. For the inbound off-peak (Inb-off) and outbound off-peak, waiting time at the intersections deviated from the mean waiting time by 1.19 to 4.16 and 1.97 to 3.90 minutes, respectively. Also, for travelers to cross through the intersections at 95% confidence, they should reserve 2.40 to 10.11 minutes during inbound off-peak and 3.40 to 6.65 minutes during outbound off-peak. However, during inbound and outbound peak hours, travelers should reserve 3.66 to 10.43 minutes and 2.45 to 5.34 minutes, respectively.



**Figure 4.8:** Buffer time at the Bus Stops and Intersections

### 4.3.6 Bus Stops based on Standard Deviations and Buffer Time

During the inbound off-peak (Inb-off) and outbound off-peak, the waiting time at the bus stops deviated from the mean waiting time by 1.27 to 5.86 minutes and 1.33 to 8.01 minutes, respectively. During peak hours, the waiting time varied from the mean waiting time by 1.09 to 9.06 minutes and 0.97 to 2.41 minutes for the inbound and outbound directions, respectively. In addition, the additional time to the mean waiting time during off-peak hours ranged from 2.18 to 13.93 minutes and 2.53 to 17.87 minutes for the inbound and the outbound directions, respectively.

A high standard deviation value was observed along the Kawe-Kariakoo route during morning peak hours, and a low standard deviation value was found along the Tegeta-Kariakoo route during morning peak hours at the bus stops and intersections. A high value of buffer time was observed along the Pugu-Kariakoo

route, followed by the Mbezi-Kariakoo route, perhaps due to construction activities along in these routes. However, a low buffer time was observed along Tegeta-Kariakoo route compared to the other routes, though it is the longest route in the city. This finding may be the result of a stable passenger flow at the bus stops. These results reveal that the waiting time at the bus stops along the Tegeta-Kariakoo route is more reliable than on the other routes.

#### 4.4 Delay Variation Distribution at the Intersections

It has been noted that travel times in urban road networks vary greatly within a short period, as well as from period to period in a single day. The major cause of this variability is the delay that drivers experience at the intersections, which differentiates developed countries from developing countries. Traffic flow in developing countries is a mixture of different modes of transport, which in turn, makes delay variation more complex. Factors, such as the speed of the different modes, the frequent interruptions of the traffic lights, and traffic police control at the intersections, contribute to delay variations. This section explores delay variations at the 41 study intersections on the five main corridors in Dar es Salaam city, as indicated in Table 4.7.

**Table 4.7:** Number of Intersections in Five Main Corridors

Corridors	Intersections	Corridors	Intersections
Kawe-Kariakoo	Morocco	Pugu-Kariakoo	Karume
	Ada Estates		Buguruni
	Kinondoni A		Tazara
	Studio		Vingunguti
	Makanya Junct.		Jet -Kipawa
	Magomeni		Airport
	Karume		Kinyerezi
Mabagala-Kariakoo	Gerazani	Tegeta-Kariakoo	Msimbazi
	Kamata		Fire
	Bandari		Salender Bridge



Corridors	Intersections	Corridors	Intersections
	Uokovu	Mbezi-kariakoo	Kinondoni Junc
	Uhasibu		Oysterbay
	Sabasaba		Namanga
Mbezi-kariakoo	Karume		Morocco
	Buguruni		Syanzi
	Tabata Dampo		Mwenge
	External		Kawe
	Ubungo		Tangi Bovu
	Kibo		Masana
	Bucha		Africana
			Mbuyuni
			Wazo hill

The proposed model estimated delay variations at the intersections during the peak and off-peak hours. The analysis was done at the moment of vehicle arrival and the moment of vehicle departure at the intersections. The delay time was considered as the independent variable and delay variation distribution as the dependent variable

**Table 4.8:** Delay Variation in Five Main Corridors

Corridors	Scenarios	Inbound Intersection Delay Time		Outbound Intersection Delay Time	
		Mean (Min)	STD(Min)	Mean (Min)	STD(Min)
Mbagala-Kariakoo	Entire delay	8.69	3.99	7.30	2.95
	Off-peak hours	4.79	4.11	7.61	2.74
	Peak-hours	8.40	4.01	6.75	3.26
Pugu-Kariakoo	Entire delay	4.66	3.48	3.24	1.99
	Off-peak hours	4.13	2.81	3.54	2.20
	Peak-hours	5.51	4.25	2.70	1.41
Tegeta-Kariakoo	Entire delay	4.25	1.91	5.30	2.23
	Off-peak hours	4.27	2.06	5.26	2.43
	Peak-hours	4.22	1.61	5.38	1.83
Mbezi-Kariakoo	Entire delay	4.43	1.96	4.28	1.79
	Off-peak hours	4.00	1.19	4.57	1.97
	Peak-hours	5.14	2.67	3.76	1.29
Kawe-Kariakoo	Entire delay	4.84	4.23	4.08	3.61
	Off-peak hours	4.56	3.68	4.41	3.90
	Peak-hours	5.30	5.02	3.47	2.97

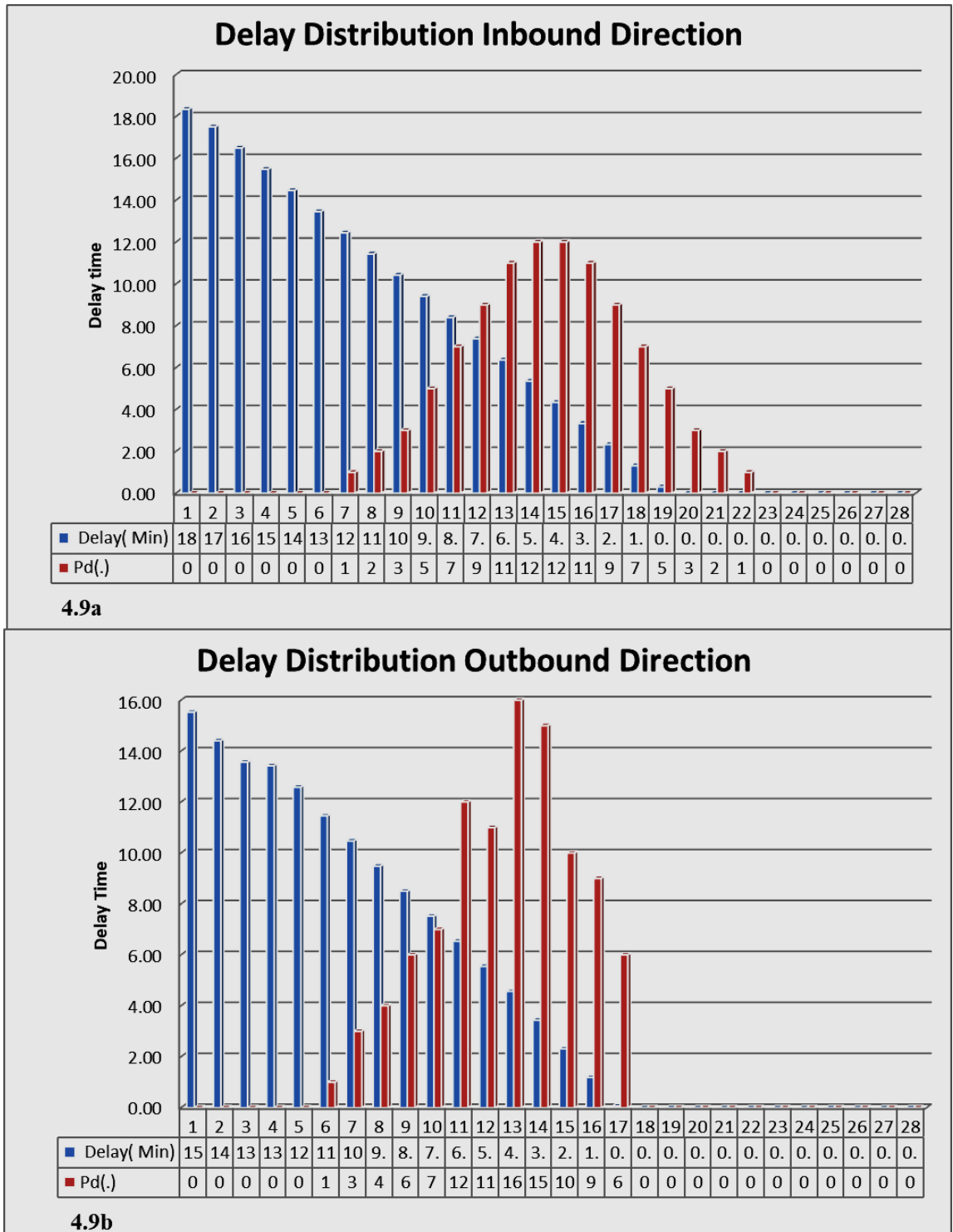
From Table 4.8, the average delay time ranged from 4.00 to 8.69 minutes for the inbound direction, while for outbound direction, the average time ranged from 2.7 to 7.61 minutes. The delay variation an individual vehicle experienced at the intersections ranged from 1.19 to 5.02 minutes (about 4 minutes), and from 1.29 to 3.9 minutes (about 3 minutes) for the inbound and outbound directions, respectively. This implies that there is a greater chance of a vehicle spending less than or equal to 4 minutes and 3 minutes in waiting time (i.e.,  $\text{delay} < 4$  minutes and  $\text{delay} < 3$ ) at every intersection in the city for inbound and outbound directions, respectively.

The average delay time of an individual vehicle experienced for the inbound direction ranged from 4.0 to 4.8 minutes during off-peak hours, and from 4.2 to 8.4 minutes during peak hours. Delay variation for both off-peak and peak hours was about 3 minutes. In addition, results reveal that there is no significant difference between average delay time and variation delay for the inbound direction, for both off-peak and peak hours.

The average delay outbound vehicles spend at the intersections ranged from 3.4 to 7.6 minutes and 2.7 to 6.6 minutes during off-peak and peak hours, respectively. On the other hand, delay variation in the outbound directions was about 2 minutes, for both off-peak and peak hours. Also, it has been noted that there is a significant variation during both the off-peak and peak hours for the outbound direction. However, there is a significant variation in hours during the inbound off-peak and peak periods and the outbound off-peak and peak periods.

As illustrated in Figure 4.9(a), the probability of inbound vehicles experiencing more than 2 minutes and less than 9 minutes in delay time is approximately 62%. This means that about 62% of inbound vehicles (mostly small

and medium size) are likely to spend more than 2 minutes and less than 9 minutes to cross an intersection in the city.



**Figure 4.9:** Delay distribution in inbound and outbound directions

Delay (Min) is the delay time in minutes, and

Pd(.) is delay probability Function.

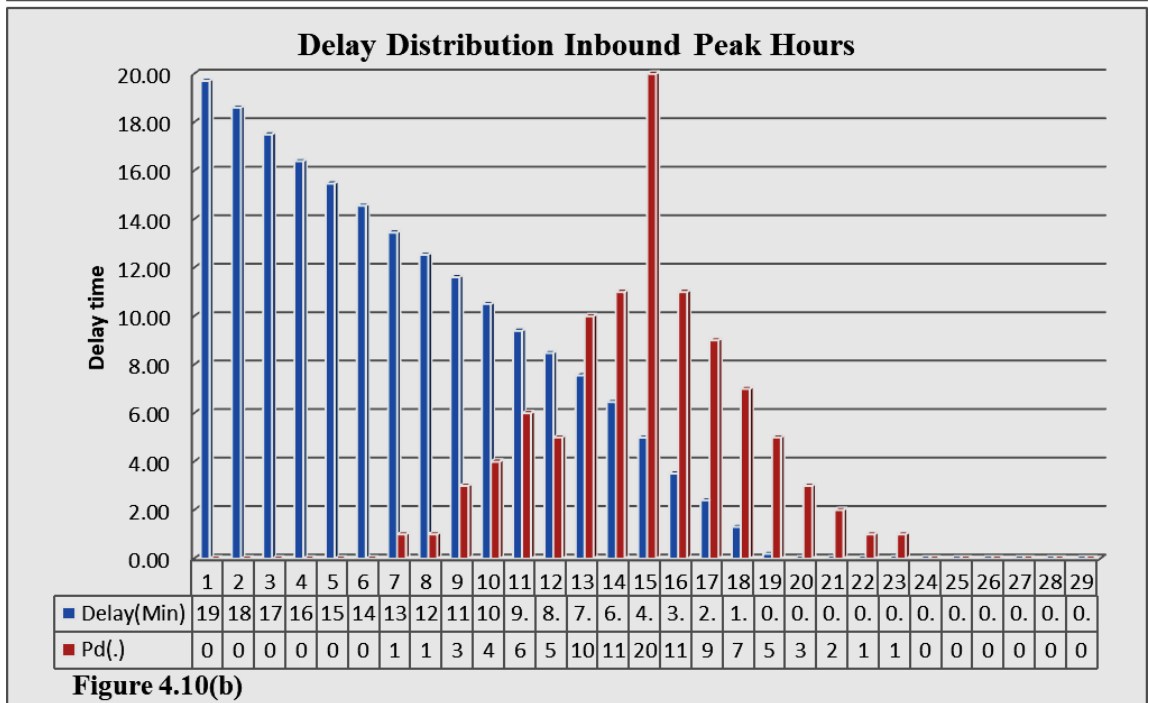
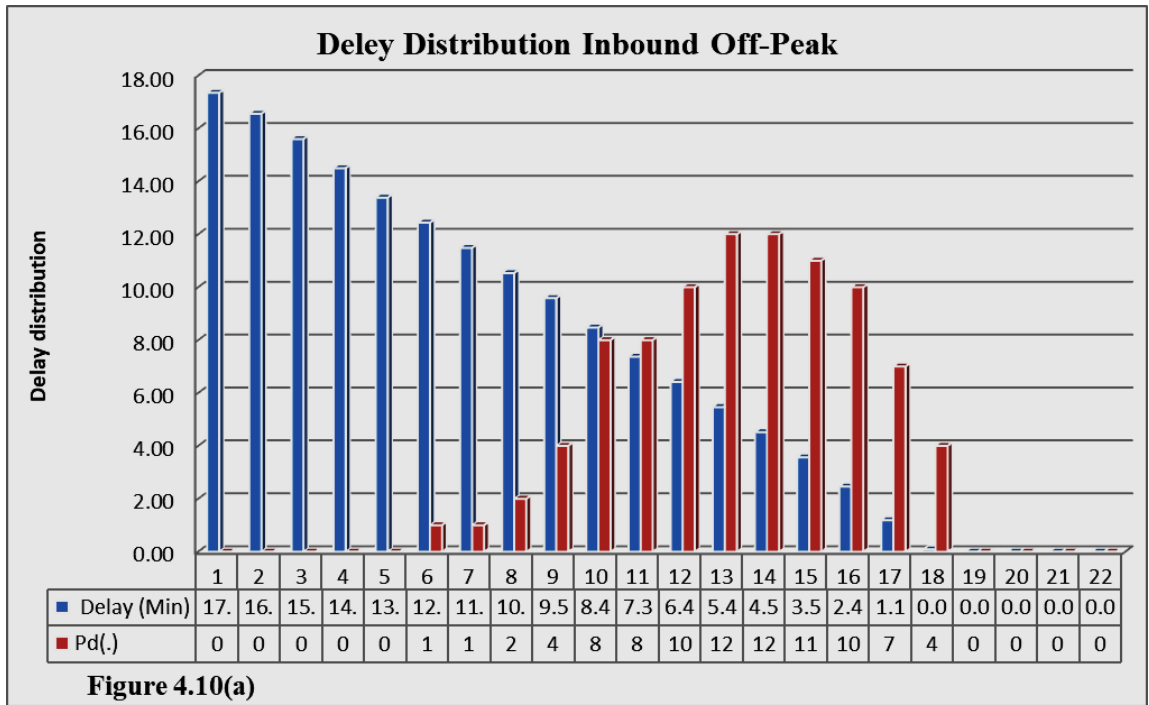
Nearly 27 % of inbound vehicles, mostly motorcycles and non-motorized transport, spend less than 2 minutes to cross an intersection in the city, while 11 % of vehicles, heavy and commercial vehicle types, spend more than 9 minutes (see Figure 4.9(a)).

From Figure 4.9(b), approximately 67% of outbound vehicles, mostly small and medium size, spend more than 2 minutes and less than 9 minutes (i.e., 2 minutes < delay < 9 minutes) to cross an intersection in the city, while 25 % of outbound vehicles, mostly motorcycles and non-motorized transport, spend less than 2 minutes (i.e., delay < 2 minutes). Only 8 % of outbound vehicles spend more than 7 minutes (i.e., delay > 9 minutes) to cross an intersections in the city, and these vehicle types consist of heavy and commercial vehicles.

During the off-peak hours, about 71% of inbound vehicles experienced a delay greater than 2 minutes and less than 9 minutes (i.e., 2 minutes < delay < 9 minutes), as shown in Figure 4.10(a). This implies that most of the vehicles arrived at the intersections already delayed by long queues and frequent traffic police control. Furthermore, there is a 13 % chance for heavy and commercial vehicles to experience a delay longer than 9 minutes (i.e., delay > 9 minutes). This result may be due to traffic congestion at the intersections. However, there is a 16 % chance that vehicles will (motorcycle) spend less than 2 minutes in delay during the off-peak hours. This result indicates that the vehicles crossed the intersections during the green signal phase, without a long wait.

During peak hours, about 72% of vehicles experienced delay for longer than 2 minutes and less than 9 minutes (2 minutes < delay < 9 minutes), while 9% of vehicles ( heavy vehicles and commercial) spent more than 9 minutes, and 19%

vehicles (motorcycles) experienced less than 2 minutes to cross an intersection, as shown in Figure 4.10(b). Interestingly, during peak hours, about 19% of vehicles (mostly motorcycles and non-motorized transport) spent less than 2 minutes, compared to 16% of similar vehicles during off-peak hours. This result is likely due to traffic police giving inbound traffic priority during peak hours compared to inbound off-peak hours, when traffic control primarily depends on the traffic signals. Also, it was noted that, motorcycles spend less time to cross at the intersection compare to other modes of transport in Dar es Salaam city.



**Figure 4.10:** Inbound off-peak and Peak Hours Delay Distribution

In Figure 4.11(a), about 75% of vehicles experienced a delay of more than 2 minutes and less than 9 minutes ( $2 \text{ minutes} < \text{delay} < 9 \text{ minutes}$ ) at the intersections.

In comparison, 19% of vehicles spent less than 2 minutes (delay < 2 minutes), and 6% of vehicles (heavy commercial vehicles) spent more than 9 minutes (delay > 9 minutes) at the intersections.

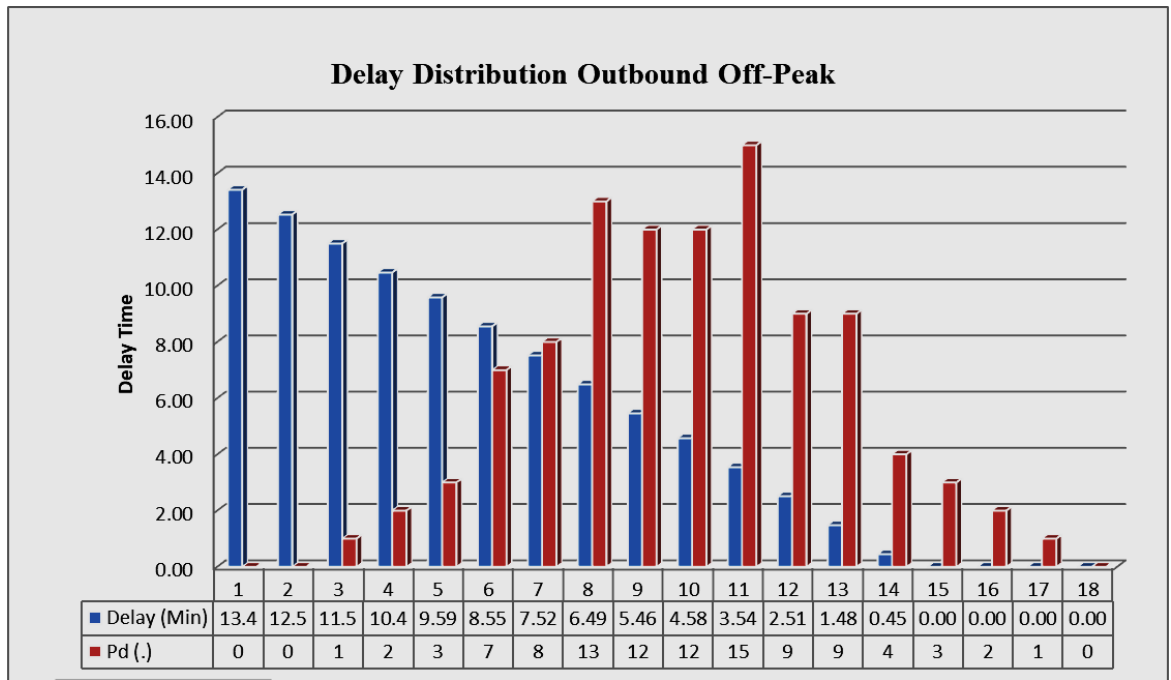


Figure 4.11(a)

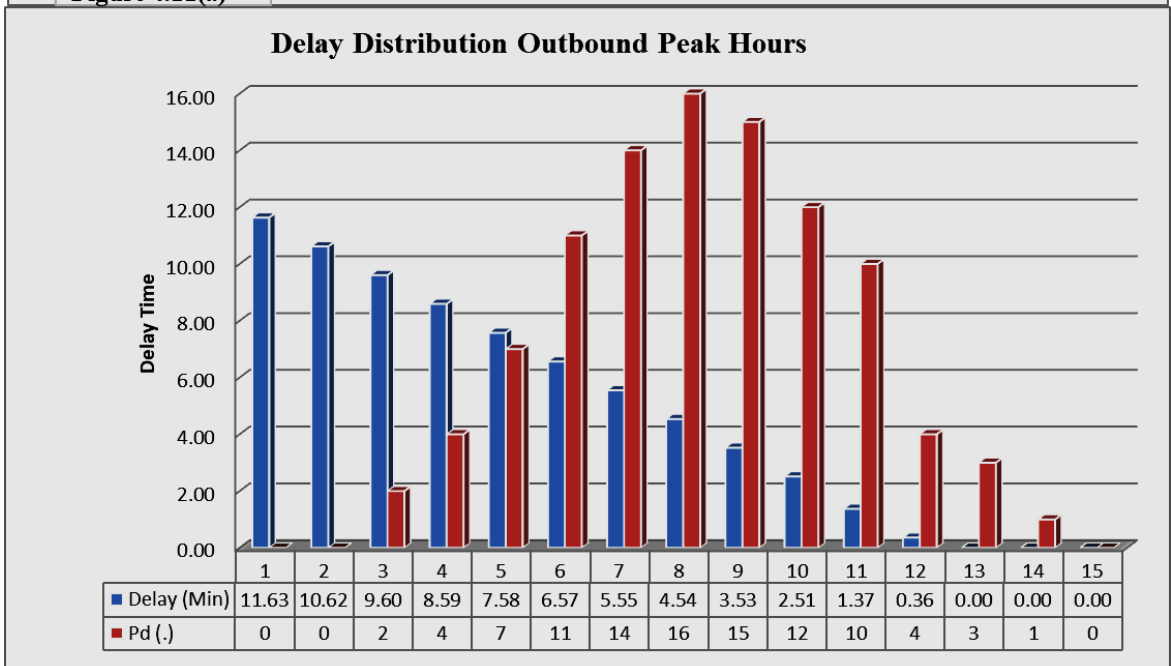


Figure 4.11(b)

Figure 4.11: Outbound off-peak and Peak Hours Delay Distribution



For peak hours, 80% of vehicles experienced delay greater than 2 minutes and less than 9 minutes (2 minutes < delay < 9 minutes), while 18% of vehicles (motorcycles) spent less than 2 minutes (delay < 2 minutes), and 2% of the vehicles spent greater than 9 minutes (delay > 9 minutes) at the intersections, as indicated in Figure 4.11(b).

Overall, during the outbound peak hours, about 80% of vehicles spend more than 2 minutes and less than 9 minutes to cross each intersection. Table 4.9 summarizes the results for peak and off-peak hours for outbound and inbound directions.

**Table 4.9:** Delay Time Distribution at the Intersections

<b>Direction</b>	<b>Vehicles (%)</b>	<b>Delay Distribution</b>
Inbound	52	2 minutes < Delay 9 minute
	32	Delay < 2 minutes
	16	Delay > 9 minutes
Outbound	70	2 minutes < Delay 9 minute
	22	Delay < 2 minutes
	8	Delay > 9 minutes
Inbound-Off-Peak-	71	2 minutes < Delay 9 minute
	16	Delay < 2 minutes
	13	Delay > 9 minutes
Inbound –Peak hours	72	2 minutes < Delay 9 minute
	19	Delay < 2 minutes
	9	Delay > 9 minutes
Outbound- Off-Peak	75	2 minutes < Delay 9 minute
	19	Delay < 2 minutes
	6	Delay >9 minutes
Outbound Peak hours	80	2 minutes < Delay 9 minute
	18	Delay < 2 minutes
	2	Delay > 9 minutes

*Comparison Delay distribution at intersection*

Delay time range from 2 to 9 minutes, mostly are passenger vehicles such min buses, Pick-up and saloons. Delay time less than 2 minutes these are motorcycles and Bajaj, while delay time greater than 9 minutes these are heavy trucks.

The results reveal that about 75% of cars spend 2 to 9 minutes to cross at the intersections traveling in the outbound directions, compared to 65% of cars traveling in the inbound directions. This suggests that during outbound peak hours, people essentially evacuate the city center within the same time period, which results in an influx of traffic flow along the five main corridors in the city.

## **CHAPTER 5 – CONCLUSION AND RECOMMENDATIONS**

### **5.1 Introduction**

This chapter presents conclusions and recommendations regarding the three specific objectives outlined and discussed in Chapter 1. In this study, a dynamic model for urban travel time prediction was modeled by applying Artificial Neural Network in collaboration with the dynamic Kalman Filter algorithm, and based on heterogeneous traffic flow conditions. The model was calibrated and validated using field data (primary and secondary data). Furthermore, urban travel time reliability was analyzed, as well as the delay time variation at the intersections under heterogeneous traffic flow conditions. In this chapter, conclusions, based on the research performed for this thesis, are presented in Section 5.2. The applicability of the results for practitioners, as well as implications for policy makers, are indicated in Sections 5.3 and 5.4, respectively. Finally, Section 5.5 provides recommendations for future research.

### **5.2 Conclusion**

Travel time estimation and prediction have been investigated by many researchers, as discussed in the literature review in Chapter 2. This thesis presents a different way of determining urban dynamic travel times, route travel time reliability, and delay time variation at intersections with different urban traffic flow conditions. The main contributions of this thesis are the development of a dynamic travel time model, calibration and validation of the model, and determination of reliability and delay variations at intersections under heterogeneous traffic flow conditions.

### 5.2.1 Literature Review

In Chapter 2, the current state of practice in modeling urban dynamic travel times was presented. Three aspects of this study were discussed: urban travel time prediction, route travel time reliability, and delay time variability. Several existing approaches, including both model-based and data-driven methods, were evaluated in terms of their strengths and weaknesses in estimating or predicting urban travel time. The literature review revealed that established urban travel time prediction models have poor transferability and cannot be applied to evaluate urban travel time under heterogeneous traffic flow conditions. Furthermore, there are few urban travel time models that take into account delay time at intersections and waiting time at bus stops under heterogeneous traffic flow conditions. Urban traffic is a mixture of motorized and non-motorized vehicles, which can shift laterally from one lane to another, thus causing physical variations and travel time variation in the urban road networks (Preethi *et al.*, 2016). Moreover, the lack of lane discipline at intersections causes notable lateral movement, and vehicles tend to use lateral gaps to move to the front of the queue.

Route travel time reliability has been widely investigated. Different approaches have been proposed to describe urban travel time reliability given in a specific traffic condition, such as statistical distributions. However, the main drawback of these techniques is that they are based on homogeneous traffic flow conditions. Therefore, applying these techniques under heterogeneous traffic conditions may not represent real world conditions (Torrise *et al.*, 2017).

Delay time at intersections contributes nearly 50% to urban travel time (Zheng and Van Zuylen, 2011). Knowing the delay time vehicles experience at intersections is important for assessing the level of service of an urban road network. The accurate prediction of delay time has a significant influence on the final estimation or prediction of travel times. However, traffic flow in most cities in developing countries is chaotic, due to the mixed traffic and vehicles sharing the same lane. Moreover, the lack of lane discipline at the intersections causes notable lateral movement, and vehicles tend to use lateral gaps to move to the front of the queue. Under these conditions, the prediction of intersection delay time is very difficult. In addition, estimating the delay variation distribution using available models, which were developed under homogeneous traffic conditions, will not provide realistic results if directly applied to heterogeneous traffic conditions.

### **5.2.2 Dynamic Urban Travel Time Prediction Model**

Chapter 3 discussed the development of the urban travel time prediction model for the five main corridors in the Dar Es Salaam city by applying Artificial Neural Network (ANN) in collaboration with the dynamic Kalman Filter (KF) algorithm. Multiple linear Regression (MLR) and ANN models were developed using waiting time at intersections, bus waiting time, number of bus stops, link distance, peak and off-peak hours, traffic volume, and travel time as input variables (i.e., input data). The models were compared in terms of their performance using R-squared, Mean Absolute Percentage Error (MAPE), and Root Mean Square Error (RMSE), and the ANN model outperformed the MLR model. The ANN model was integrated with the KF dynamic algorithm to produce an ANN-KF dynamic model, and the ANN-KF model outperformed the ANN model.

### **5.2.2.1 Model Validation**

The travel time from the ANN-KF model was compared to the data observed in the field. Validation of the ANN-KF model was performed based on the RMSE and MAPE to measure the accuracy of the travel time model. Findings indicate that the ANN-KF model promised to be a reasonable model for predicting the dynamic travel time on the five main corridors in Dar Es Salaam city.

### **5.2.2.2 Model Performance**

The prediction accuracy was assessed and compared with the ANN model, employing R-squared. The ANN model R-squared ranged from 82 to 84 percent, which means that over 82 percent of the dependent variable (observed urban travel time) was explained by the independent variable, which is estimated urban travel time by the ANN. About 99 percent of the predicted travel time from the ANN-KF model explained travel time from the ANN model, which implies that 99 percent of the expected travel time by the ANN-KF model was well fitted in the ANN model.

### **5.2.3 Travel Time Reliability**

The second objective of this research intended to analyze travel time reliability based on urban bus operational characteristics in heterogeneous traffic conditions. This objective evaluated travel time reliabilities in terms of travel time in the route links, waiting times at the bus stops, and delay time at the intersections. Four techniques were applied, including buffer time, standard deviation, coefficient of variation, and planning time. Data were obtained through ground observations and recordings of waiting times at the intersections and bus stops. Link travel time was collected using public transport, which operates on the five corridors in the Dar Es Salaam city. The overall results

indicate low service reliability in the outbound directions compared to the inbound directions.

#### **5.2.4 Delay Variation at the Intersections**

The third objective of this research intended to determine the delay time variation at the intersections under heterogeneous traffic flow conditions. The study evaluated the delay time distribution under three scenarios of traffic flow conditions: the entire delay (inbound and outbound), off-peak hours (inbound and outbound), and peak hours (inbound and outbound). Results indicate that during the outbound peak hours, about 80% of vehicles spend more than 2 minutes and less than 9 minutes to cross each intersection, followed by outbound off-peak, inbound peak, and lastly, inbound off-peak. Most of the vehicles spend more delay time (ranging from 2 to 9 minutes) in the outbound directions than the inbound directions because people almost evacuate the city center at nearly the same time, which results in an influx of traffic onto the five main corridors of the city. It was observed that nearly 62 % of vehicles, mostly small and medium size, are likely to experience more than 2 to 9 minutes of delay at an intersection. Further, 27 % of vehicles (motorcycles and non-motorized vehicles) are likely to spend less than 2 minutes, while 11 % of vehicles (heavy and commercial) spend more than 9 minutes to cross at the intersections.

#### **5.3. Practical Usability of the Results**

The results presented in this thesis provide several implications for practical applications. The travel time prediction models developed in this thesis can be used for travel time assessment. The present navigation systems provide mean travel times for urban routes based on average traffic conditions or only a few probes. The model

proposed in this thesis could give the prediction of the whole range of urban travel times and inform transport planners and road users to promote a better use of urban road network and address urban transport challenges.

Travel time prediction on urban roads is a difficult subject. The proposed models can be used for urban link or trip travel time predictions. Chapter 3 discussed the possibility of applying the model for prediction purposes. The full range of urban route travel times could be predicted for a short time period (e.g., 15 minutes, 30 minutes), though the validation of the prediction procedure using field data is limited by the fact of insufficient field road sensors, vehicles with installed GPS data, reliable probe vehicles, and traffic data centers, which are necessary for validating the prediction method.

Travel time reliability is considered an important aspect in departure time and route choice models. Standard deviation, buffer time, coefficient of variation, and planning time were applied to capture the uncertainty associated with travel time. The effectiveness of using these parameters lies in the fact that the travel time distribution is normal. However, travel time distributions are rarely normal (more likely skewed) on urban roads. In this study, the travel time reliability was determined to provide the possibility to better incorporate travel time uncertainty in departure time and route choice models.

#### **5.4 Policy Implications**

Travel time information is one of the instruments that enable transportation engineers, planners, operators, and transport service users to determine measures for reducing congestion, journey length, and environmental pollution. Furthermore, it enables road users to explore the existing urban road network more efficiently. This



leads to an improvement of existing road infrastructure and increased passenger and cargo flows in the city. Furthermore, it will have an immediate positive impact on national economic development, growth of employment, and the prosperity. Moreover, the development of environmentally friendly transport and the extensive construction of by-pass routes will contribute to achieving ecological balance and enhance the quality of life in cities. Therefore, it is expected that the outcome of this study may be a guideline for policy makers in formulating appropriate strategies for improving urban mobility and accessibility.

Furthermore, travel time prediction and reliability are very important information on transport policy agendas in Tanzania. The following implications can be made for practitioners and policy makers:

- The travel time prediction model developed in this thesis provides the possibility to assess travel time reliability in urban areas. The influence of traffic demand, traffic supply, traffic control schemes, and heterogeneous traffic flow behavior for urban travel time can be explicitly considered.
- The fundamental investigation of urban travel time mechanisms provides the possibilities to influence the travel time prediction, and as a consequence, to influence the travel time reliability from different aspects.
- Demand: the influences of traffic demand measures (e.g., congestion pricing) on travel time reliability can be quantified.
- Supply: the influences of the change in traffic supply on travel time reliability can be explicitly investigated.

- Traffic control: the traffic control scheme (cycle time, green splits, and offsets) can be optimized to provide a most reliable link/route.
- Heterogeneous traffic flow conditions: heterogeneous traffic flow condition processes at intersections cause uncertainty, delay time at the intersections, and urban travel times. These factors should always be considered in urban travel time reliability models.

### **5.5 Recommendations**

- i. The proposed model was calibrated and validated using data collected from the five main corridors in the Dar Es Salaam city. Therefore, transport planners and policy-makers will be expected to make decisions based on the outcome of this developed model. It is recommended that more data should be collected on more than the five main corridors in order to compare with the predicted travel time from the ANN-KF model, and to ensure that the model will accurately represent real travel time in Dar es Salaam city.
- ii. The present study is the first attempts to predict bus travel time in Dar Salaam by applying Artificial Neural Network with four layers to estimate baseline travel time. To improve this model in future, it is recommend that, advance Artificial Neural Network could be applied.
- iii. Lack of clear indices for evaluating transport services can lead to poor service, misuse of road capacity, and increased urban congestion. Providing travel time reliability is expected to raise awareness for policy makers to shift from expanding road networks towards optimizing road operations and quality of services.

- iv. This research has focused on five main corridors in Dar es Salaam, which contain controlled intersections. Urban roads with roundabouts and street road networks were not addressed in this study. The variation of traffic in terms of oversaturation and under-saturation, in short periods, under similar traffic conditions was not considered. In this research, no special attention was given to different vehicle classes or traffic composition. Future research may improve the current model by incorporating the aforementioned variables.
- v. Many factors seem to influence urban travel time and its variability, as discussed in Chapter 1. The research mentioned many factors that influence urban travel time, but only five factors were considered in this study. Other factors, such as bus manoeuvres at the bus stops, crossing pedestrians and cyclists, turning vehicles from cross streets, and weather conditions were not explicitly considered; however, they could be included in future studies.
- vi. The study determined the duration of travel time reliability in five corridors in Dar es Salaam; it is recommended that in future study, focus should be on modeling of travel time reliability that will provide more information to transport planners on how to improve level of service in Dar es Salaam. Furthermore, this study determines travel reliability based on delay time intersections, waiting time at bus stops and in-vehicle travel time as main factors. It is also recommended that future studies should consider other factors such weather condition, driver behavior and traffic flow state.

- vii. The research determines route travel time reliability, which has been analyzed using traffic flow data collected for only one week. To make the travel time variability model reliable need more time, thus data collection should be extended by applying modern equipment, such as inductive loop detectors.
  
- viii. The delay time variation at the intersections was evaluated based on delay time recorded during field data collection. Other factors, such as long queue and random traffic flow at the intersections, should be considered in future studies.

## REFERENCES

- Abdalla, M. F., Mohamed, A. 2006. Modeling Travel Time under ATIS Using Mixed Linear Models. *Transportation* , vol. 33(1): pp 63–82.
- Adan, I., Resing, J. 2010. A queueing based traffic flow model. *Transportation Research-D*, vol. 5 . 2, pp:121-135.
- AKÇELİK, R. 1988. The Highway Capacity Manual Delay Formula for Signalised Intersections. *The Institute of Transportation Engineers*, vol. 58(3):pp 23-27.
- Akcelik, R., Roupail, N.1993. Estimation of Delays at Traffic Signals for Variable Demand Conditions. *Transport Research Board*, vol. 278:pp 109-131.
- Al-Deek, H. M., Emam, B. E. 2006. Computing Travel Time Reliability in Transportation Networks with Multistates and Dependent Link Failures. *Journal of Computing in Civil Engineering* ,vol 20(5):pp17–27.
- Al-Duais, M. S., Yaakub, A. R., Yusoff, N. 2013. Dynamic Training Rate for Backpropagation Learning Algorithm. *IEEE 11th Malaysia International Conference on Communications*,pp:77-82.
- Altinkaya, M., Metin, Z. 2013. Urban Bus Arrival Time Prediction: A Review of Computational Models. *International Journal of Recent Technology and Engineering*,vol. 2(4)
- Amita, J., Jain, S. S., Garg, P. K. 2016. Prediction of Bus Travel Time Using ANN: A Case Study in Delhi. *Transportation Research Procedia*,vol. 17 pp:263-72.

- Amita, J., Jain S. S., Garg, P. K. 2015. Prediction of Bus Travel Time Using Artificial Neural Network. *Prediction of Bus Travel Time Using Artificial Neural Network*, vol. 5(4) :pp442-450.
- Anil, K. B., Vanajakshi, L., Subramanian, S. C. 2017. A Hybrid Model Based Method for Bus Travel Time Estimation. *Journal of Intelligent Transportation Systems: Technology, Planning, and Operations*, vol.22(5): pp 390-406.
- Arnold, T., Bertus, M., Godbey, J. 2007. A Simplified Approach to Kalman Filter Technique in Excel. *Journal of Applied Finance*.
- Bacon, J. A., Bejan, A. B., David, E., Richard, J. G., Ken, M. 2011. Using Real-Time Road Traffic Data to Evaluate Congestion. *15 JJ Thomson Ave., Cambridge CB3 0FD, UK, University of Cambridge*,
- Bai, C., Zhong-ren, P., Qing-chang, L., Jian, S. 2015. Dynamic Bus Travel Time Prediction Models on Road with Multiple Bus Routes. *Computational Intelligence and Neuroscience*, pp 1-9.
- Bharti, A. K., Ch Ravi, S., Satish, C. 2018. Travel Time Reliability as a Level of Service Measure for Urban and Inter-Urban Corridors in India. *Current Science*, vol.114(9) pp13-22.
- Bhaskar, A., Chung, E., Dumont, A. G. 2009. Integrating Cumulative Plots. and Probe Vehicle for Travel Time Estimation on Signalized Urban Network. *9th. Swiss. Transport Research. Conference*.
- Bhourri, N., Maurice, A., Gerard, S. 2016. Travel Time Reliability with and without

the Dynamic Use of Hard Shoulder: Field Assessment from a French Motorway. *Journal of Traffic and Transportation Engineering*, vol 3(6) :pp 20-30.

Čelan, M., Marjan, L. 2017. Bus Arrival Time Prediction Based on Network Model. *Procedia Computer Science*,vol. 113: pp 38-45.

Charlotte, C., Le Maitre, H., Benelli, S. 2017. Empirical Estimation of the Variability of Travel Time. *Transportation Research Procedia*,vol. 25: pp 69-83.

Chen, H., Rakha, A. H., McGhee, C. 2014. Dynamic Travel Time Prediction Using Genetic Programming. *15th International IEEE Conference on Intelligent Transportation Systems*,

Chen, M., Chein,S. 2001. Dynamic Freeway Travel Time Prediction Using Probe Vehicle Data: Link-Based vs. Path-Based. *Transportation Research Record*,vol. 01 :pp157-161.

Chen, M., Liu, X. B., Xia, J. X. 2004. A Dynamic Bus Arrival Time Prediction Model Based on (APC) Data. *Computer Aided Civil and Infrastructure Engineering*,vol. 19 :pp 64-76.

Chen, P., Huan L., Hongsheng, Q., Fu-jian W. 2013. Analysis of Delay Variability at Isolated Signalized Intersections. *Journal of Zhejiang University Science*, vol 14(10): pp 691-704.

Chen, P., Jian, S., Hongsheng, Q. 2016. Estimation of Delay Variability at Signalized Intersections for Urban Arterial Performance Evaluation. *Journal of Intelligent*

*Transportation Systems: Technology, Planning, and Operations*, vol. 21(2): pp 94-110.

Chen, X., Lei Y., Yushi Z., Jifu, G. 2009. Analyzing Urban Bus Service Reliability at the Stop, Route, and Network Levels. *Transportation Research Part A: Policy and Practice*, vol.43(8): pp 22-34.

Cheng, C., Yuchuan, D., Lijun, S., Yuxiong, J. 2015. Review on Theoretical Delay Estimation Model for Signalized Intersections. *Transport Reviews*, vol. 36(4):pp 79-99.

Chien, S. I. J., Ding, Y., Wei, C. 2002. Dynamic Bus Arrival Time Prediction with Artificial Neural Networks. *Journal of Transportation Engineering* vo.128(4): pp29-38.

Chien, S., Chandra, M. K. 2003. Dynamic Travel Time Prediction with Real-Time and Historic Data. *Journal of Transportation Engineering*, vol. 129(6): pp 08-16.

Chien, S., Xiaobo, L. 2012. An Investigation of Measurement for Travel Time Variability. *Intelligent Transportation Systems*, vol. 71(67): pp 20-40.

Da Silva, I. N., Danilo, H. S., Rogerio, A. F., Luisa, H. L., Silas, F. A. 2017. Artificial Neural Network Architectures and Training Processes. *Springer International Publishing Switzerland*, DOI 10.1007/978-3-319-43162-8\_2

Dutch National data, 2018. Road sensor detectors Pictures, <https://www.google.com>

Durán-Hormazábal, E., Alejandro, T. 2016. Estimation of Travel Time Variability for Cars, Buses, Metro and Door-to-Door Public Transport Trips in Santiago,



Chile. *Research in Transportation Economics*, vol. 59: pp 26–39.

Elhenawy, M., Hao, C., Hesham, A. R. 2014. Dynamic Travel Time Prediction Using Data Clustering and Genetic Programming. *Transportation Research Part C: Emerging Technologies*, vol. 42: pp 82–98.

Ernst, J., Christopher, D., James, K., Darcy, B. 2012. Probe Data Sampling Guidelines for Characterizing Arterial Travel Time. *Transportation Research Record*, vol.23(15): pp 73–81.

Faghri, A., Hamad, K. D., Magdefrau, J. R., Yeung, W. 2014. Application of Global Positioning System (Gps) to Travel Time and Delay Measurements. *Newark, University of Delaware*.

Fan, W., Zegeye, G. 2015. Dynamic Travel Time Prediction Models for Buses Using Only GPS Data. *International Journal of Transportation Science and Technology*, vol 4(4): pp 53–66.

FDOT, 2016. Guide to Planning for Travel Time Reliability. *Florida, Transportation Asset Management Plan*.

FHWA, 2005. Traffic Congestion and Reliability, Trends and Advanced Strategies for Congestion Mitigation, Massachusetts. *Cambridge Systematics, Inc*, [www.camsys.com](http://www.camsys.com)

FHWA, 2010. Travel Time Reliability: Making It There on Time, All the Time. Minnesota. <http://mobility.tamu.edu/mmp>

Fosgerau, M., Daisuke, F. 2012. Valuing Travel Time Variability : Characteristics of

- the Travel Time Distribution on an Urban Road. *Transportation Research Part C*, vol. 24 (2012): pp83–101.
- Fu, L., Bruce, H. 2000. Delay Variability at Signalized Intersections. *Transportation Research Record*, vol 2(1710): pp 15–21.
- Ghiassi, M., Saidane, H., David, K. Z. 2005. A Dynamic Artificial Neural Network Model for Forecasting Time Series Events. *International Journal of Forecasting*, vol. 21(2): pp 341–62.
- Gittens, A., Amer, S. 2015. Evaluation of Bus Reliability Measures and Development of a New Composite Indicator. *Transportation Research Record*, vol. 25(33): pp 91–99.
- Guessous, Y., Maurice, A., Neila, B., Simon, C. 2014. Estimating Travel Time Distribution Under Different Traffic Conditions. *Transportation Research Procedia*, vol 3 ( 2014) :pp 339 –348
- Gupta, S. 2009. Delay at Signalized Intersection. *Indian Institute of Technology*, vol 28(2009): p p21–34.
- Gurmu, K.z., Nall, T., Wei, F. I. 2014. Artificial Neural Network Travel Time Prediction Model for Buses Using Only GPS Data. *Journal of Public Transportation*, vol.17(2):pp 45–65.
- Hadiuzzaman, M., Rahman, A., Karim, M, A. 2009. Saturation Flow Model at Signalized Intersection for Non-Lane Based Traffic Md. *Canadian Journal of Transportation* ,vol. 2 ( 1) (2009): pp78–90.

- Hall, F. L. 1992. Traffic Stream Characteristics. *Hamilton, Canada L8S 4L7*
- Hashim, I. H., Abdel-wahed, T. A., Mandor, A. M. 2017. Measuring Control Delay At Signalized Intersections. *International Journal of Advance Research in Science and Engineering*,vol.5: pp 124- 138
- Hawas, Y. 2013. Simulation-Based Regression Models to Estimate Bus Routes and Network Travel Times. *Journal of Public Transportation*, vol. 16(4):pp107–130.
- Hellinga, B., Pedram, I., Hiroyuki, T., Liping, F. 2008. Decomposing Travel Times Measured by Probe-Based Traffic Monitoring Systems to Individual Road Segments. *Transportation Research Part C: Emerging Technologies*, vol.16(6): pp 68–82.
- Jain, V., Ashlesh, S., Lakshminaraynan, S. 2012. Road Traffic Congestion in the Developing World. *Proceedings of the 2nd ACM Symposium on Computing for Development*,pp.32-47.
- Jammula, J. K., Rajesh, B., Kodavanti, V., Raghavendra, R. 2018. Travel Time Prediction Modelling in Mixed Traffic Conditions. *International Journal for Traffic and Transport Engineering* vol. 8(1): pp 35–47.
- Jeong, R., Laurence, R. 2004. Bus Arrival Time Prediction Using Artificial Neural Network Model. *IEEE Intelligent Transporlatlon Systems* vol. 51(6):pp 88–103.
- Jiang, Z., Cunbao, Z., Yinxia, X. 2014. Travel Time Prediction Model for Urban

- Road Network Based on Multi-Source Data. *Procedia - Social and Behavioral Sciences*, vol.138: pp 811–18.
- Jindal, I., Tony, Q., Xuewen, C., Matthew, N., Jieping, Y. 2017. A Unified Neural Network Approach for Estimating Travel Time and Distance for a Taxi Trip. *Transportation Research Board 92nd Annual Meeting*, vol. 13
- Kieu, L. M., Ashish, B., Edward, C. 2013. Empirical Evaluation of Public Transport Travel Time Variability. *Australasian Transport Research Forum*, pp 1-18.
- Kiran, N. M., Kasireddy, P. R. 2016. Analysis of Saturation Flow at Signalized Intersections in Urban Area. *International Journal Advane Research in Science and Engineering*, pp 20-30.
- Kormáksson, M., Luciano, B., Marcos. R. V., Bianca, Z. 2014. Bus Travel Time Predictions Using Additive Models. *IEEE International Conference on Data Mining Bus 10-15*.
- Krishnamoorthy, R. K. 2008. Travel Time Estimation and Forecasting on Urban Roads. *PhD thesis, University of London* ,
- Kuang, A., Zhiqiang, T., Liangci, S. 2013. Road Network Capacity Reliability Considering Travel Time Reliability. *Procedia - Social and Behavioral Sciences*, vol. 96: pp 1818-1827.
- Kumar, B. A., Vanajakshi, L., Subramanian, C., Shankar, C. 2014. Pattern-Based Bus Travel Time Prediction under Heterogeneous Traffic Conditions Pattern-Based Bus Travel Time Prediction under Heterogeneous Traffic Conditions.

*Transportation Research Board*

- Kumar, B. A., Lelitha, V., Shankar, C. S. 2017. Bus Travel Time Prediction Using a Time-Space Discretization Approach. *Transportation Research Part C: Emerging Technologies* vol 79:308-332.
- Kwon, J., Benjamin, C., Peter, B. 2000. Day-to-Day Travel-Time Trends and Travel-Time Prediction from Loop-Detector Data. *Transportation Research Record*, vol 17 (17): pp 120–129.
- Li, M., Wu, H., Wang, Y., Handroos, H., Carbone, G. 2017. Modified Levenberg-Marquardt Algorithm for Backpropagation Neural Network Training in Dynamic Model Identification of Mechanical Systems. *Journal of Dynamic Systems, Measurement and Control*, vol 139(3).
- Li, M., Xuesong, Z., Nagui, M. R. 2016. Quantifying Travel Time Variability at a Single Bottleneck Based on Stochastic Capacity and Demand Distributions. *Intelligent Transportation Systems Technology, Planning, and Operations*, pp 1–56.
- Lighthill, M.J., Whitham, G. B. 1955. On Kinematic Wave II , a Theory of Traffic Flow on Long Crowded Roads. *Proceedings of the Royal Society of London*.
- Lin, W, H., Zeng, J. 1999. An Experimental Study on Real Time Bus Arrival Time Prediction with GPS Data. *Center for Transportation Research* ,vol. 14: pp 105-130
- Liu, H., Zuylen, H., Lint, W. C., Salomons, M. 2006. Urban Arterial Travel Time

Prediction with State-Space Neural Networks and Kalman Filters.

*Transportation Research Record: Journal of the Transportation Research Board*, vol 1968(1):99–108.

Liu, H., Henk, J., Zuylen, H., Lint, W., Yusen, C., Ke, Z. 2005. Prediction of Urban Travel Times with Intersection Delays. *IEEE Conference on Intelligent Transportation Systems, Proceedings*, pp:1062–1067.

Lu, C. 2017. Estimate Freeway Travel Time Reliability Under Recurring and Nonrecurring Congestion. *PhD Thesis in Iowa State University*.

Lyman, K. 2007. Travel Time Reliability in Regional Transportation Planning. *PhD. Thesis in Portland State University*.

Lyman, K., Robert, L. B. 2008. Using Travel Time Reliability Measures to Improve Regional Transportation Planning and Operations. *Journal of the Transportation Research Board*, vol 2046, (2046): pp1-10.

Margiotta, R., Douglas, M. 2013. Travel Time Reliability as a Service Measure for Urban Freeways in Florida. *Transportation Research Board*, 94612(510):pp 1-30.

Mathew, T. 2014a. Fundamental Relations of Traffic Flow. *Khanna Publishers, New Delhi, 1987*

Mathew, T. 2014. Signalized Intersection Delay Models. *Khanna Publishers, Bombay India*

Mehran, B. 2009. Considering Travel Time Reliability and Safety for Evaluation Of

Congestion Relief. *Iatss Research Vol. 33(1):pp 55-70.*

Miller, A. J. 1963. Settings for Fixed-Cycle Traffic Signals. *Operational Research Society, vol. 14(4): pp 373-386.*

Mori, U., Alexander, M., Maite, Á., Jose, A. L. 2015. A Review of Travel Time Estimation and Forecasting for Advanced Traveller Information Systems. *Transportmetrica : Transport Science, vol. 11(2): pp 119-157.*

Newell, G.F. 1965. Approximation Methods for Queues with Application to the Fixed-Cycle Traffic Light. *Society for Industrial and Applied Mathematics, vol. 7(2):pp 223–240.*

OECD, 2010. Improving Reliability on Surface Transport Networks.  
*www.oecd.org/publishing/corrigenda, OECD Ilibrary*

Olszewski, P.S. 1993. Modeling Probability Distribution of Delay at Signalized Intersections. *Journal of Advanced Transportation, vol. 28(3): pp 253–274.*

Panomruttanarug, B., Richard, W. L. 2008. The Advantages and Disadvantages of Kalman Filtering in Repetitive Control. *Advances in the Astronautical Sciences ,vol.129( 2):pp1433–1452.*

Preethi, P., Varghese, A., Ashalatha, R. 2016. Modelling Delay at Signalized Intersections under Heterogeneous Traffic Conditions. *Transportation Research Procedia, vol.17(2014):pp 529–538.*

Russell, M. B. 2014. Travel Time Reliability and Level of Service. *PhD. Theses in Louisiana State University.*

- Salonen, M., Tuuli, T. 2013. Modelling Travel Time in Urban Networks: Comparable Measures for Private Car and Public Transport. *Journal of Transport Geography*, vol. 31:pp 143-153.
- Sen, R., Pankaj, S., Bhaskaran, R. 2011. RoadSoundSense: Acoustic Sensing Based Road Congestion Monitoring in Developing Regions. *8th Annual IEEE Communications Society Conference on Sensor, Mesh and Ad Hoc Communications and Networks*, pp125-133.
- Shalaby, A., Ali, F. 2003. Bus Travel Time Prediction Model for Dynamic Operations Control and Passenger Information Systems. *Proceedings of the CD-ROM. Transportation Research Board 82nd Annual Meeting, National Research Council*
- Shi, C., Chen, B., Qingquan, L. 2017. Estimation of Travel Time Distributions in Urban Road Networks Using Low-Frequency Floating Car Data. *ISPRS International Journal of Geo-Information*, vol. 6(8):253-268
- Ta-Yin, H., Wei-Ming, H. 2010. Travel Time Prediction for Urban Networks : The Comparisons of Simulation-Based and Time-Series Models. *Proceedings of the 9th IEEE International Conference on Intelligent Transportation system*, pp. 493–498,
- Taylor, M. A. P., Susilawati, M. 2012. Modelling Travel Time Reliability with the Burr Distribution. *Procedia Social and Behavioral Sciences*, vol. 54: pp 75-83.
- Tian, D., Yong, Y., Honggang, Q., Yingrong, L., Wang. Y., Xia, H., Anping, H.



2015. A Dynamic Travel Time Estimation Model Based on Connected Vehicles. *Mathematical Problems in Engineering*, pp 1-11.
- Torrise, V., Matteo, I., Giuseppe, I. 2017. Estimating Travel Time Reliability in Urban Areas through a Dynamic Simulation Model. *Transportation Research Procedia* 27:857–64.
- Transportation Research Board Executive Committee (TRB). 2000. *Highway Capacity Manual (HCM)*
- Turner, S. M., Eisele, W., Benz, R. J., Holdener, D. J. 2008. Travel Time Data Collection Handbook. *National Technical Information Service (NTIS), Virginia* 22161
- Vanajakshi, J., Subramanian, S., Sivanandan, C. 2008. Travel Time Prediction under Heterogeneous Traffic Conditions Using Global Positioning System Data from Buses. *IET Intelligent Transport Systems*, vol.3,(21): pp 1-9.
- Vanajakshi, L., Shankar, C. S., Akhilesh, K. 2016. Development of a Real Time Bus Arrival Time Prediction System under Indian Traffic Conditions. *APTS for Indian Cities, Madras Chennai*.
- Vanajakshi, L., Laurence, R. 2007. Support Vector Machine Technique for the Short Term Prediction of Travel Time. *2007 IEEE Intelligent Vehicles Symposium*, pp 600–615.
- Vanderval, A., Louch, H., Guerre, J., Margiotta, R. 2014. Incorporating Reliability Performance Measures into the Transportation Planning and Programming

Processes. *Cambridge Systematics, Inc Washington, D.C.*

Viti, F., Henk J. Z. 2010. Probabilistic Models for Queues at Fixed Control Signals. *Transportation Research Part B: Methodological vol. 44(1):pp 120-135.*

Wang, L., Zhongyi, Z., Junhao, F. 2014. Bus Arrival Time Prediction Using RBF Neural Networks Adjusted by Online Data. *Procedia - Social and Behavioral Sciences, vol. 138: pp 67-75.*

Webster, 1958. Traffic Signals settings. *Road Research Laboratory London, Her Majesty Stationary Office.*

Wu, C., Jan-ming, H., Lee, D. T. 2004. Travel-Time Prediction With Support Vector Regression. *IEEE Transactions on Intelligent Transportation Systems, Vol.,5(4):pp 276–281.*

Wu, F., Xiaowei, H., Shi, A., Duo, Z. 2019. Exploring Passengers' Travel Behaviors Based on Elaboration Likelihood Model under the Impact of Intelligent Bus Information. *Journal of Advanced Transportation, pp 1-12.*

Yeon, J., Lily, E., Siriphong, L. 2008. Travel Time Estimation on a Freeway Using Discrete Time Markov Chains. *Transportation Research Part B: Methodological, vol. 42(4): pp 325-338.*

Yusuf, A. 2013. Advanced Machine Learning Models for Online Travel-Time. *PhD.in Georgia Institute of Technology.*

Zaki, M., Ashour, M. Z., Hesham, B. 2013. Online Bus Arrival Time Prediction Using Hybrid Neural Network and Kalman Filter Techniques. *International*

*Journal of Modern Engineering Research (IJMER),vol.3: pp 2035-2041.*

- Zhang, F., Xinyan, Z., Tao, H., Wei, G., Chen, C., Lingjia, L. 2016. Urban Link Travel Time Prediction Based on a Gradient Boosting Method Considering Spatiotemporal Correlations. *ISPRS International Journal of Geo-Information*, vol. 5(11):pp 201-225.
- Zheng, F. 2011. Modelling Urban Travel Times. *PhD. Thesis, Delft University of Technology, Delft.*
- Zheng, F., Henk, Z. 2010. Uncertainty and Predictability of Urban Link Travel Time. *Journal of the Transportation Research Board* vol.. 2192 (2192): pp 136-146.
- Zheng, F., Henk, Z. 2011. Time Delay Distribution Based Analysis. *Transportation Research Board, Vol. 21(92):pp 124-134.*
- Zheng, F., Henk, Z. 2013. Urban Link Travel Time Estimation Based on Sparse Probe Vehicle Data. *Transportation Research Part C: vol.31: pp 145–157.*
- Zheng, F., Henk, Z., Jin, Z., Ling, J. 2015. Travel Time Distribution Estimation for Urban Signalized. : *94th annual meeting of the Transportation Research Board, 11-15 January 2015, Washington D.C*
- Zhenliang. M., Ferrira, L., Mesbah, M. Z. 2015. Modeling Distributions of Travel Time Variability for Bus Operations. *Journal of Advanced Transportation* vol. 44: pp 267-283.
- Zhou, X., Zhaosheng, Y., Wei, Z., Xiujuan, T., Qichun, B. 2015. Urban Link Travel

Time Estimation Based on Low Frequency Probe Vehicle Data. *Discrete Dynamics in Nature and Society* . vol 2016, : pp 1-13

Zhu, X., Yaxin, F., Faming, Z., Xinyue, Y. 2018. Multiple-Factor Based Sparse Urban Travel Time Prediction. *Applied Sciences*,vol.8: pp 1-18.

## APPENDICES

## APPENDIX 3.0

## 3.1 Travel Time Survey Form

TRAVEL TIME SURVEY FORM				
Date 19/9/1918	Name of Surveyor: Amedeus Mushi		No. of Sheets 1/20	
Check Points	hr	Min	Sec	Remarks
-				
Tegeta Kibaoni - African	15	23	7	traffic Congestion
-				
-	15	25	32	
-	15	25	47	
-	5	33		traffic Congestion
-	15	33	23	
-	15			
African - Mwenge	15	35	33	
-				
-				traffic Congestion
Mwenge - Victoria	15	4	47	
-				
-	15	46		
-	15	46	36	
-	15	48	55	
-	15	49	08	
Victoria - Mbuyuni	16	02	1	traffic Congestion
-				
-	15		1	
-	16			
-	16	5	5	
-	16	6		
-	16	1		traffic Congestion
-	16			
-	16			
-	16			traffic Congestion
-	16	3	44	
-	16	37	1	traffic Congestion
Mbuyuni - Kariakoo	16	37	36	
-				traffic Congestion
-	16	4	5	
-				
-	16	43	04	30 to Resting



### 3.3 Survey Maps

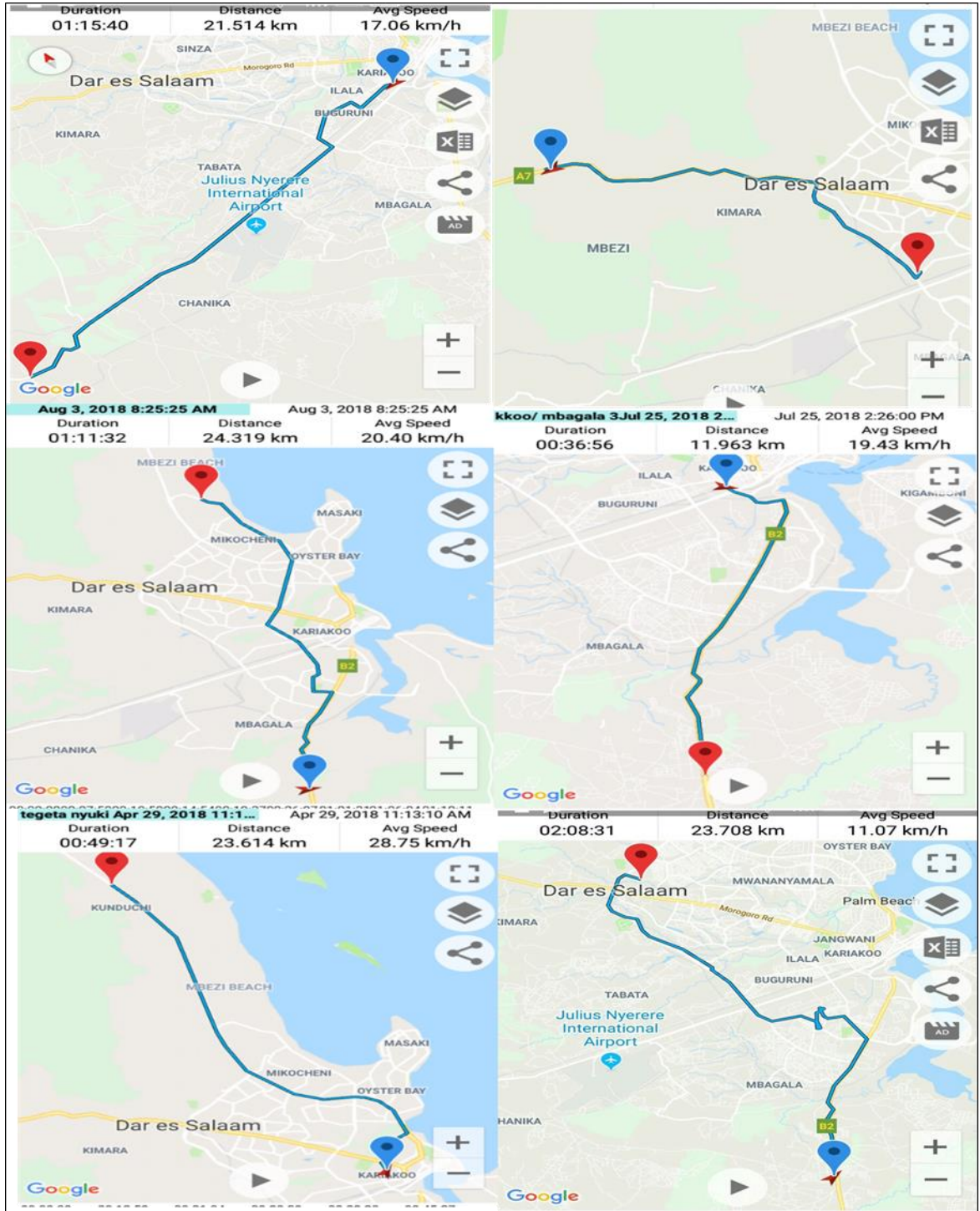


Figure: 3.3 Survey Maps





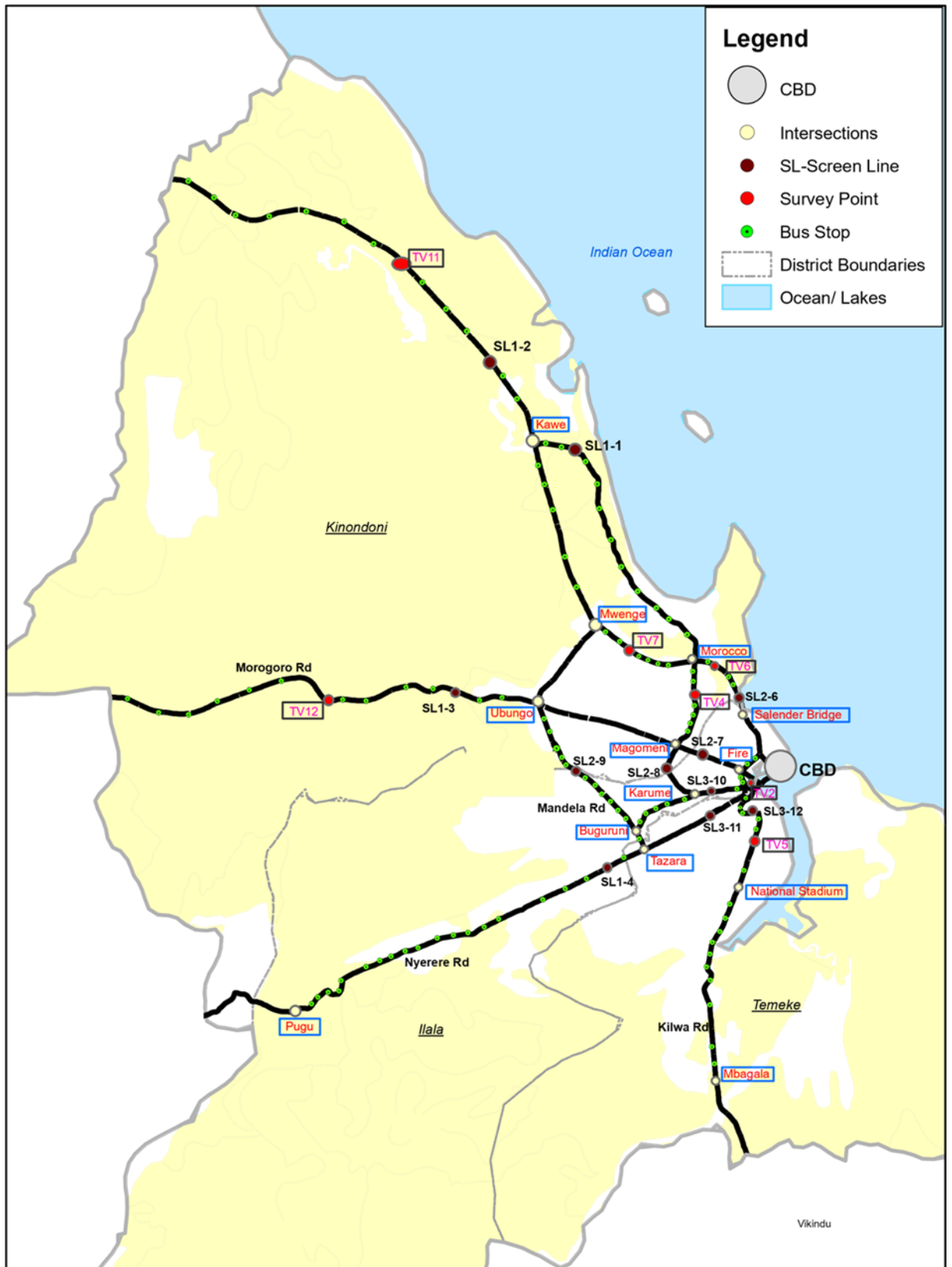
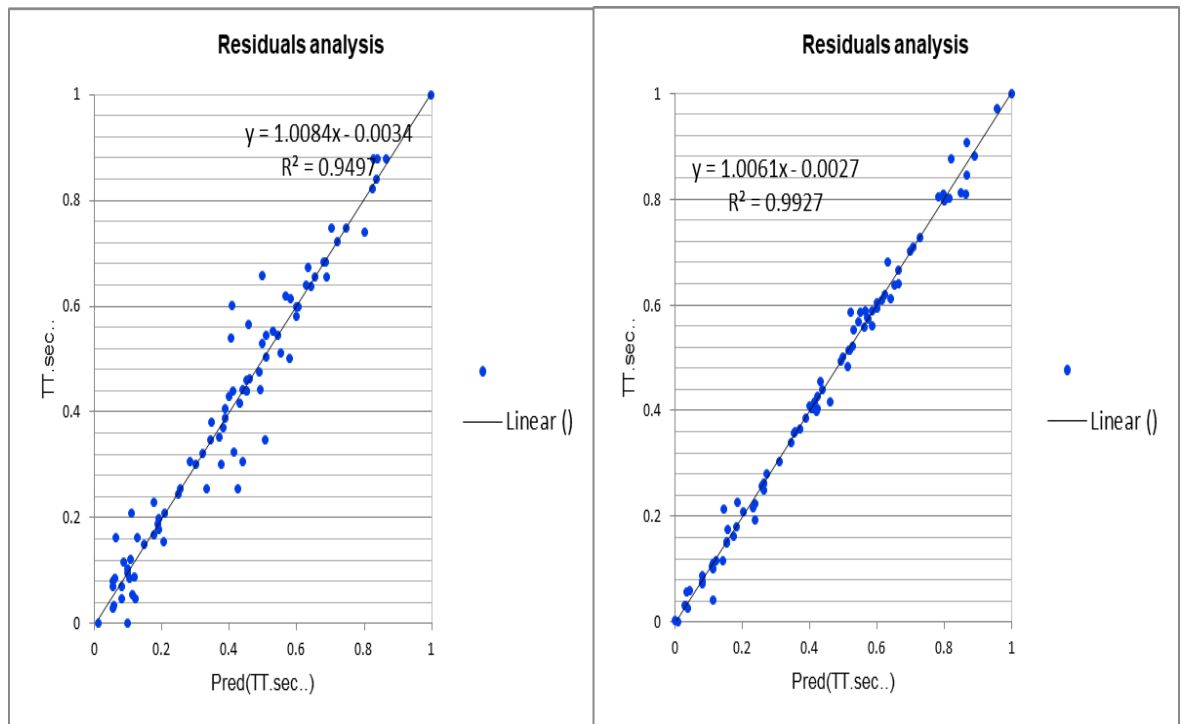


Figure: 3.4 Secondary Collection Points

**APPENDIX 4.0**

**Table 4.1:** Multiple Regression model Pugu

Variables	Coefficients Inbound	Coefficients Outbound
Intercept	0.126	0.719
Traffic states(X1)	-0.014	0.128
Waiting time at the bus stops (X 2)	0.016	-0.127
Delay time at the intersections (X3)	-0.095	0.143
Link travel distance (X4 )	0.490	-0.542
Traffic volume (X5)	0.242	-0.173
R Square	0.67	0.64

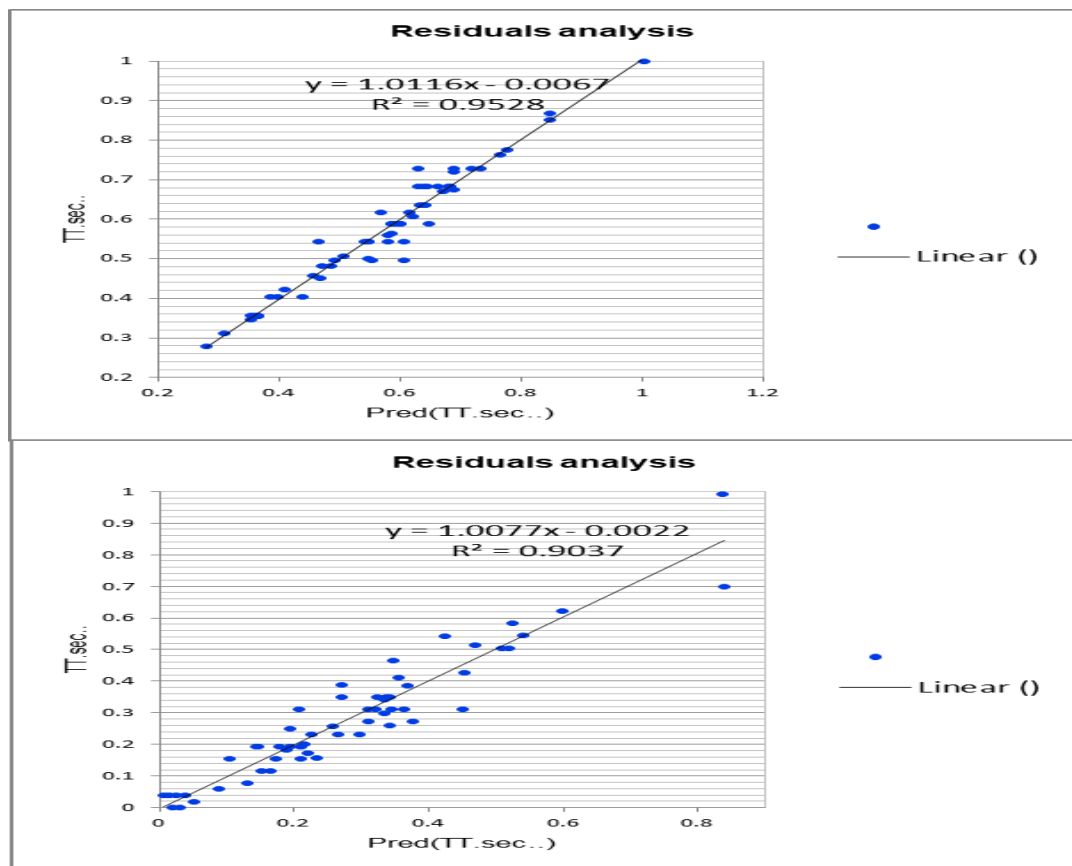


**Figure: 4.2** Artificial Neural Network model Pugu

**Table : 4.3** Multiple Regression model Mbagala

Variables	Coefficients Inbound	Coefficients Outbound
Intercept	0.545	0.298
Traffic states(X1)	0.063	-0.172

Variables	Coefficients Inbound	Coefficients Outbound
Waiting time at the bus stops (X 2)	-0.007	-0.016
Delay time at the intersections (X3)	-0.059	0.295
Link travel distance (X4 )	-0.020	0.010
Traffic volume (X5)	0.100	0.093
R Square	0.13	0.39

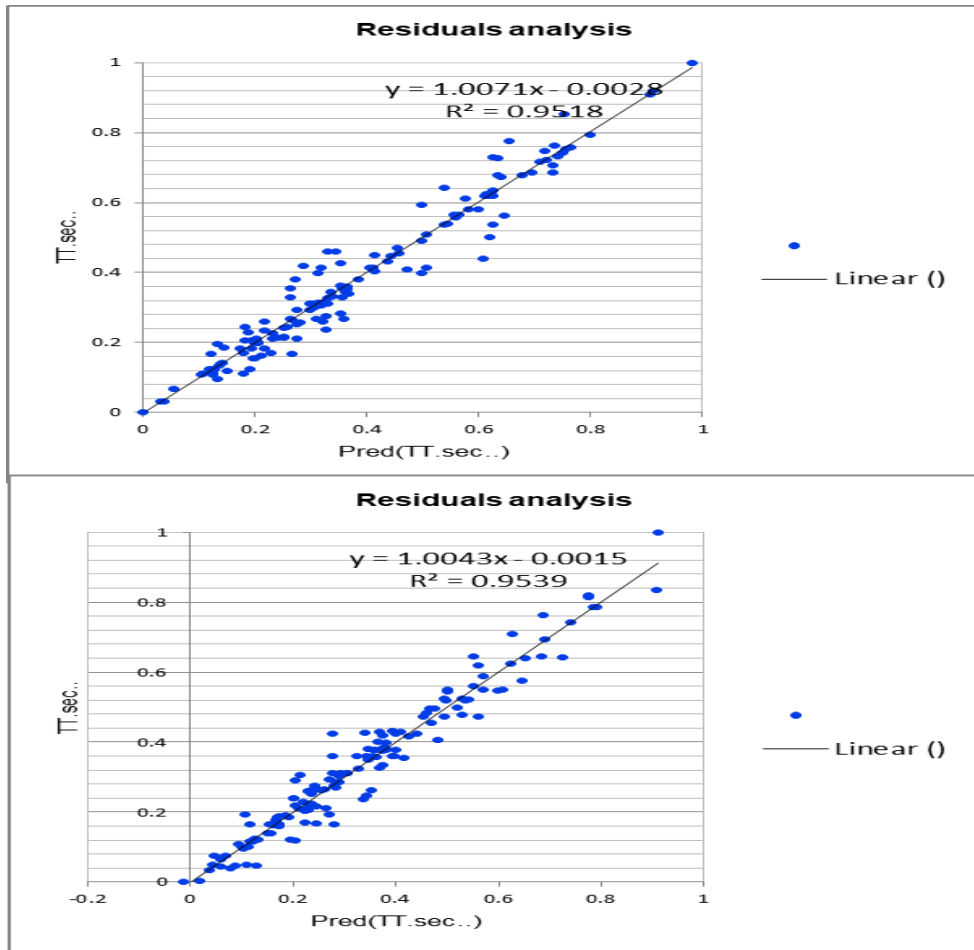


**Figure: 4.4** Artificial Neural Network model Pugu

**Table: 4.5** Multiple Regression model Tegeta

Variables	Coefficients Inbound	Coefficients Outbound
Intercept	0.129	0.086
Traffic states(X1)	0.022	0.166
Waiting time at the bus stops (X 2)	0.012	-0.088
Delay time at the intersections (X3)	-0.158	0.042

Variables	Coefficients Inbound	Coefficients Outbound
Link travel distance (X4 )	0.460	0.343
Traffic volume (X5)	0.133	0.063
R Square	0.62	0.65

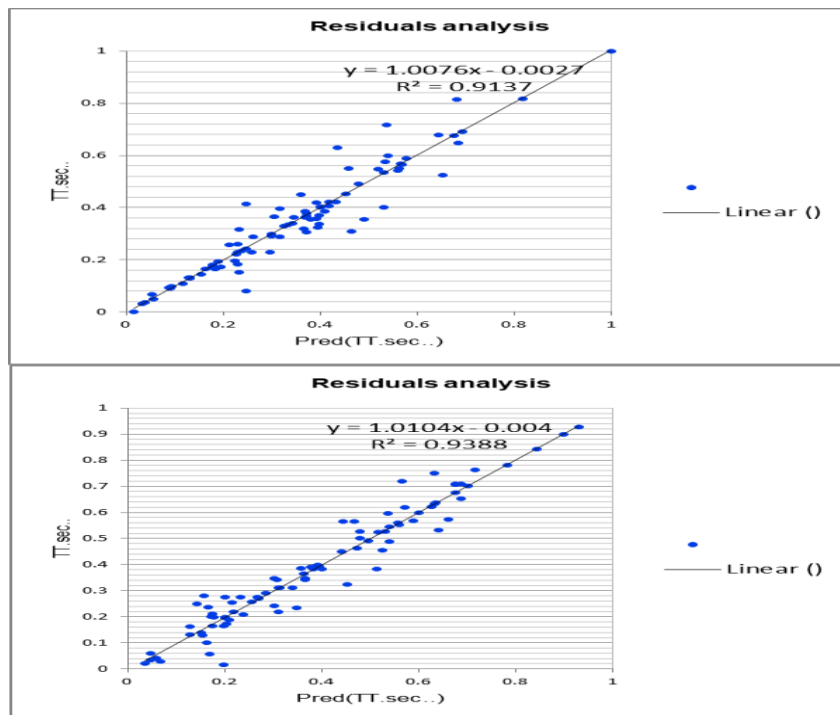


**Table: 4.6** Artificial Neural Network model Tegeta (inbound and outbound Direction)

**Table: 4.7** Multiple Regression model Kawe

Variables	Coefficients Inbound	Coefficients Outbound
Intercept	0.699	0.108
Traffic states(X1)	-0.042	-0.067
Waiting time at the bus stops (X	-0.513	-0.189

Delay time at the intersections	-0.263	-0.074
Link travel distance (X4 )	-0.078	0.300
Traffic volume (X5)	0.100	0.599
R Square	0.28	0.38



**Figure: 4.8** Artificial Neural Network model Kawe (inbound and outbound Direction)

## APPENDIX 5.0

### Travel time Reliability

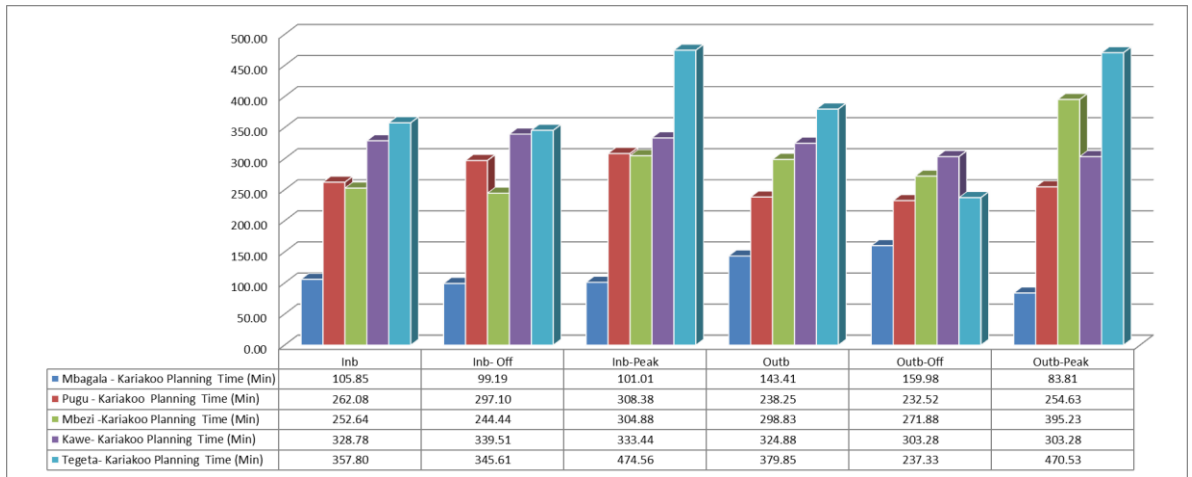


Figure: 5.1(a) Planning Time

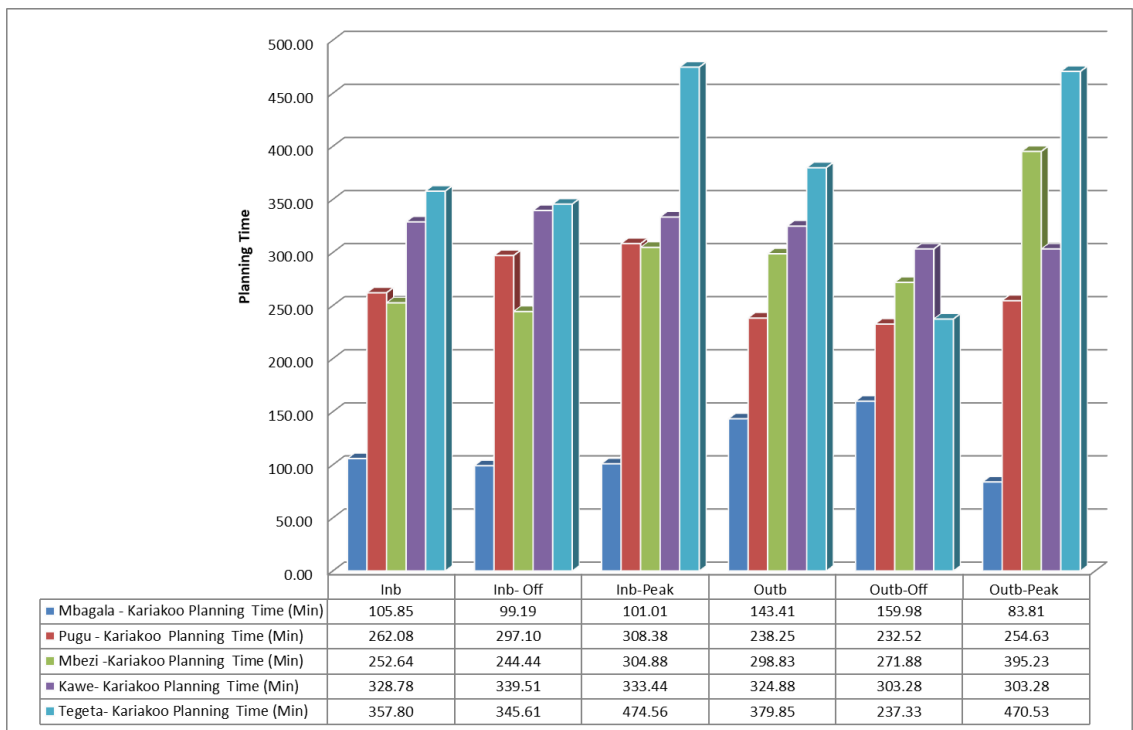


Figure: 5.1(b) Planning Time

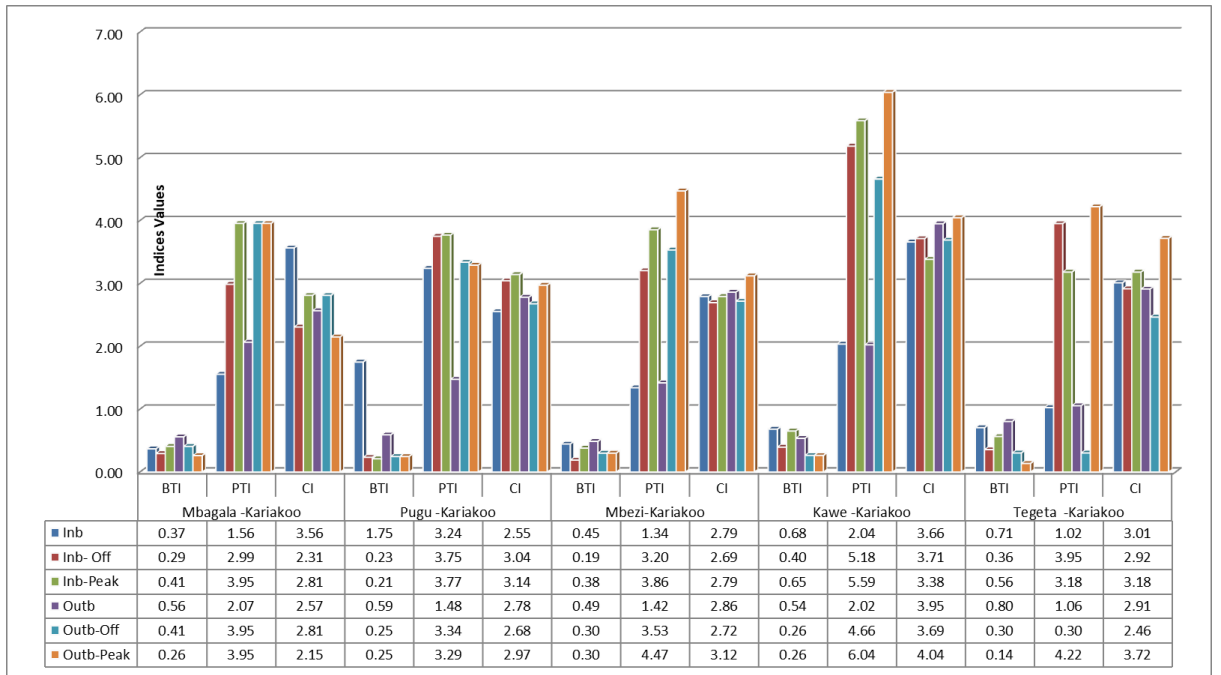
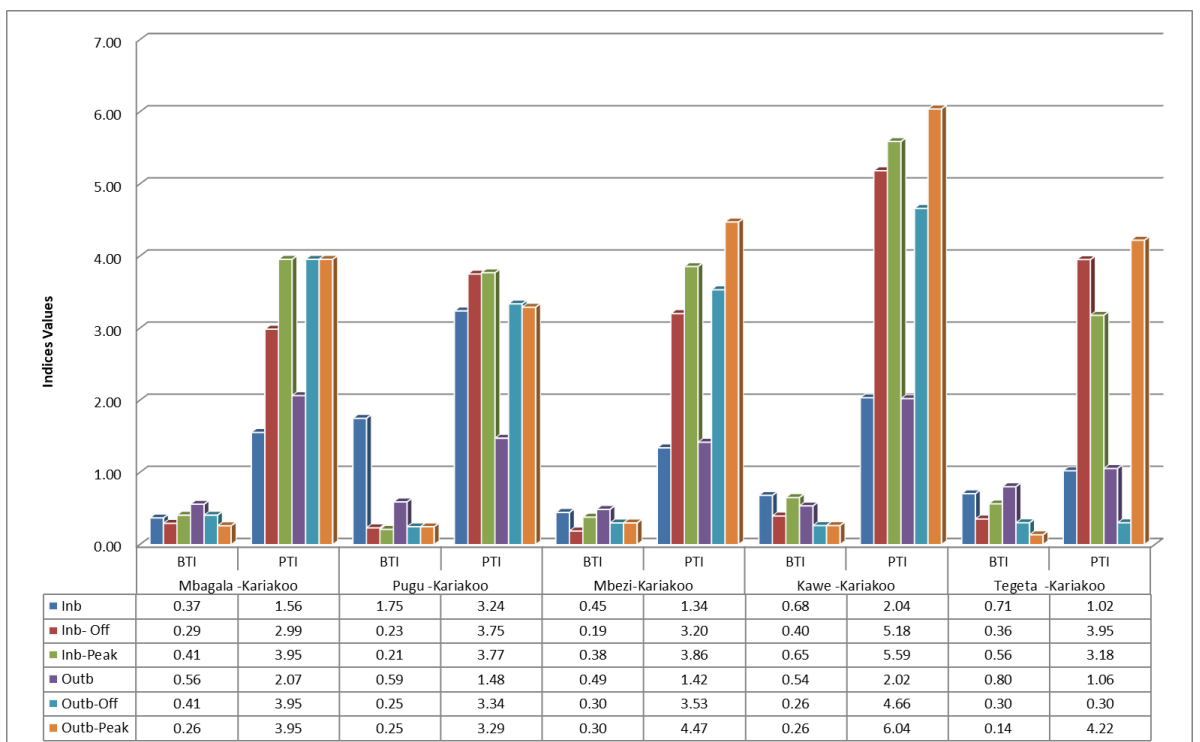


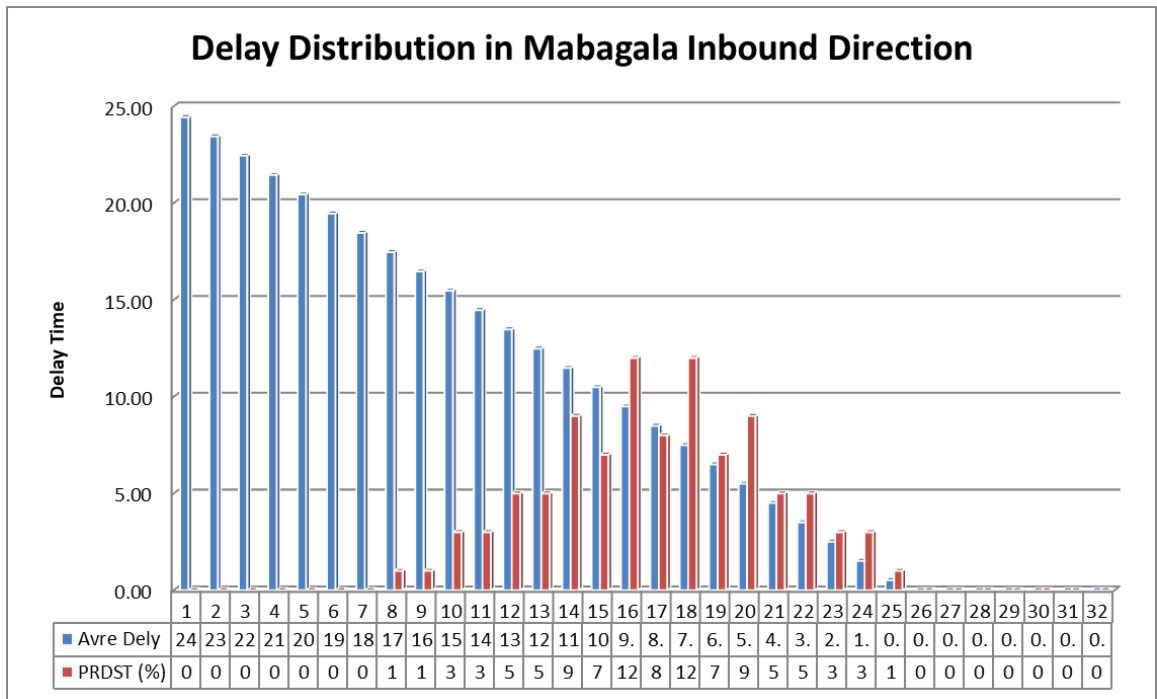
Figure: 5.2(a) Planning Time Index and Coefficient of Variation



**Figure: 5.2(b)** Planning Time and Buffer Time Index

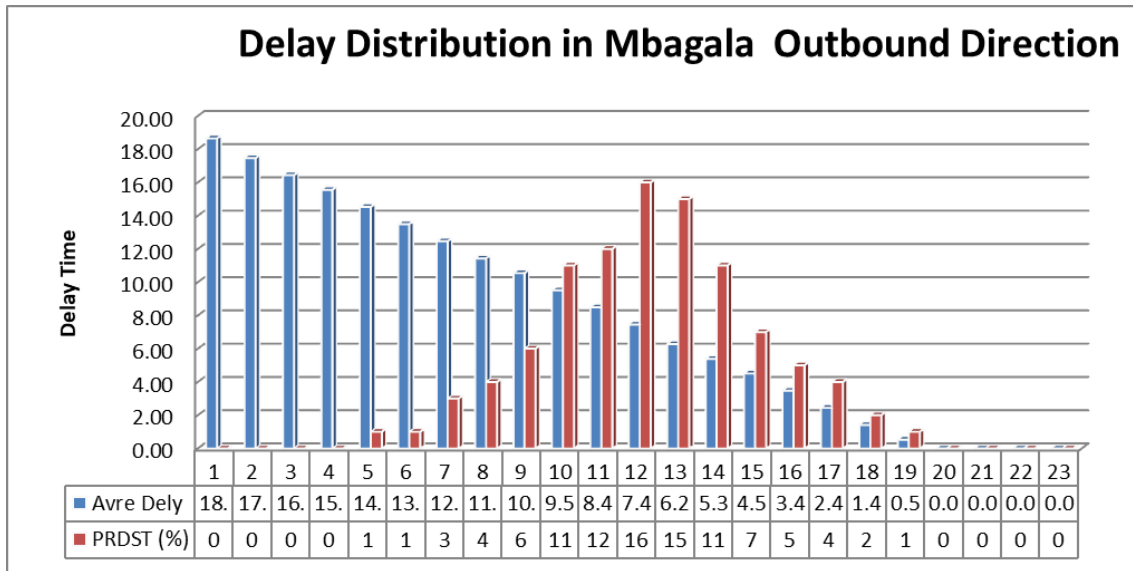
**APPENDIX 6.0**

**Delay Distribution at Intersection**

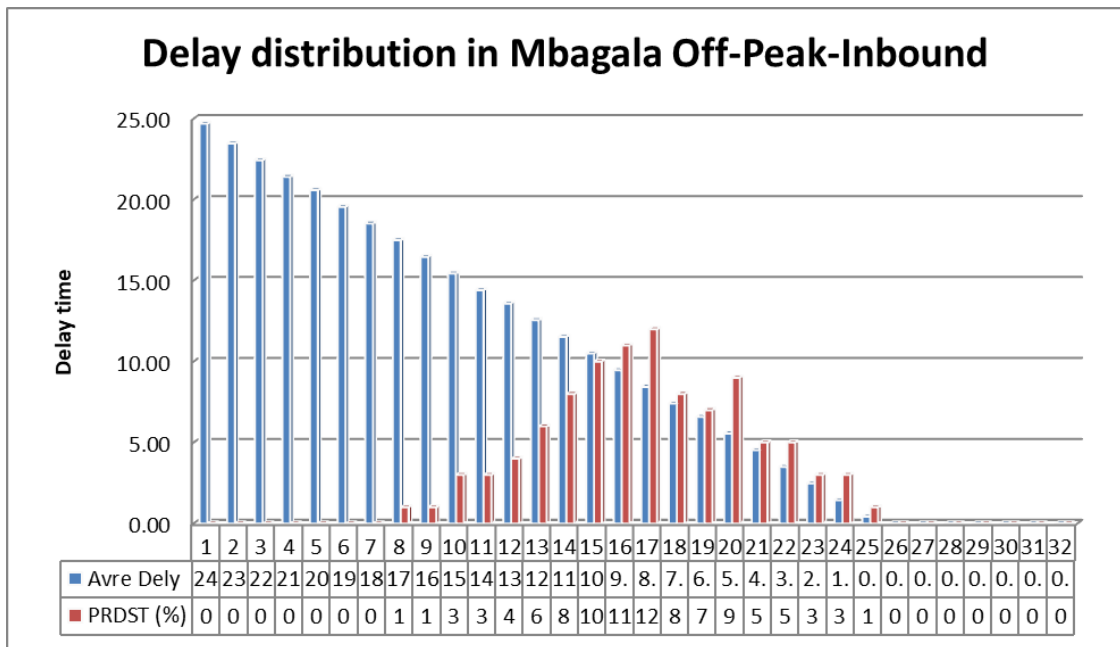


**Figure: 6.1(a)** Delay Distribution at Intersection Inbound Direction

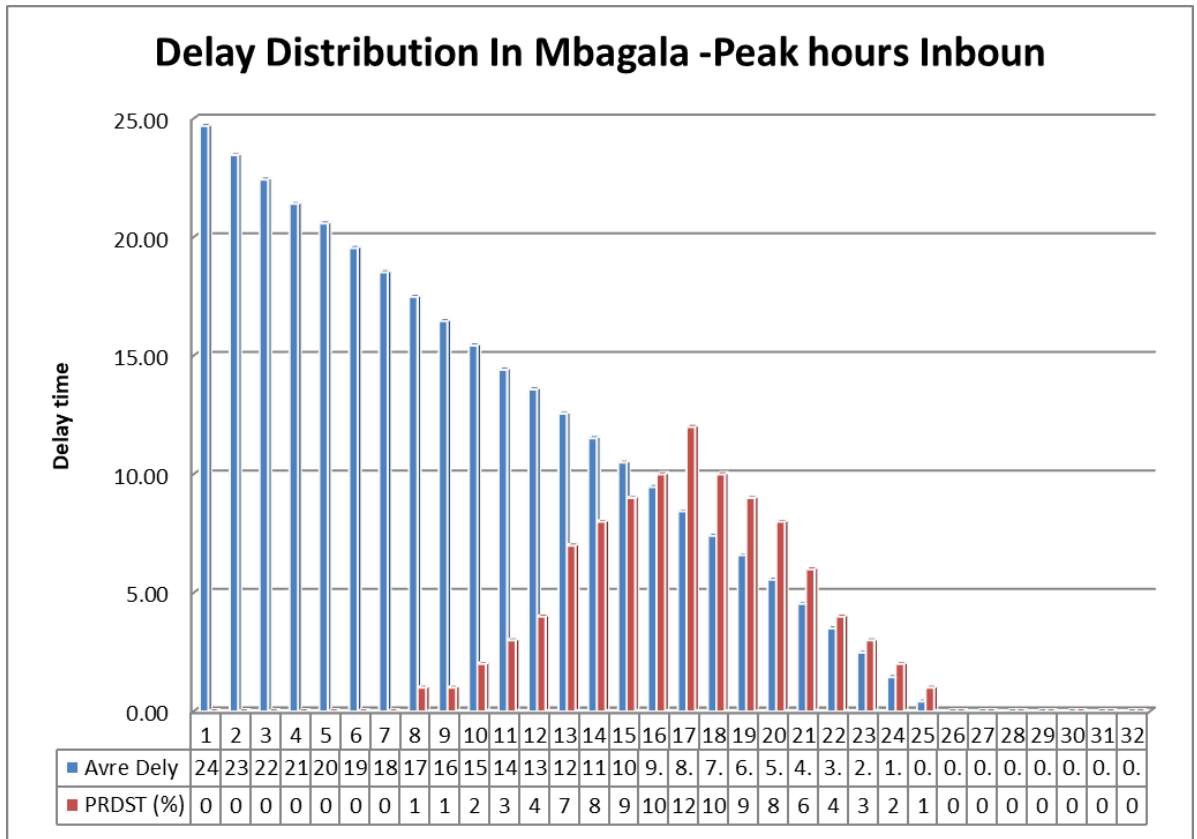




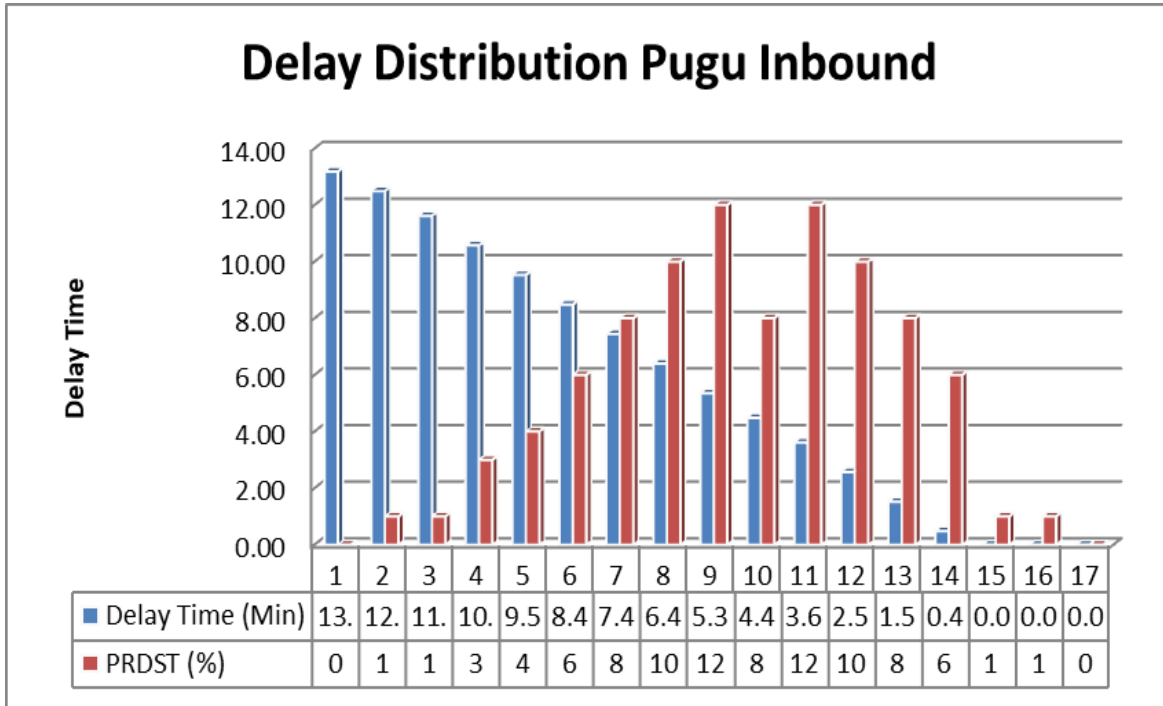
**Figure: 6.1(b)** Delay Distribution at Intersection Outbound Direction



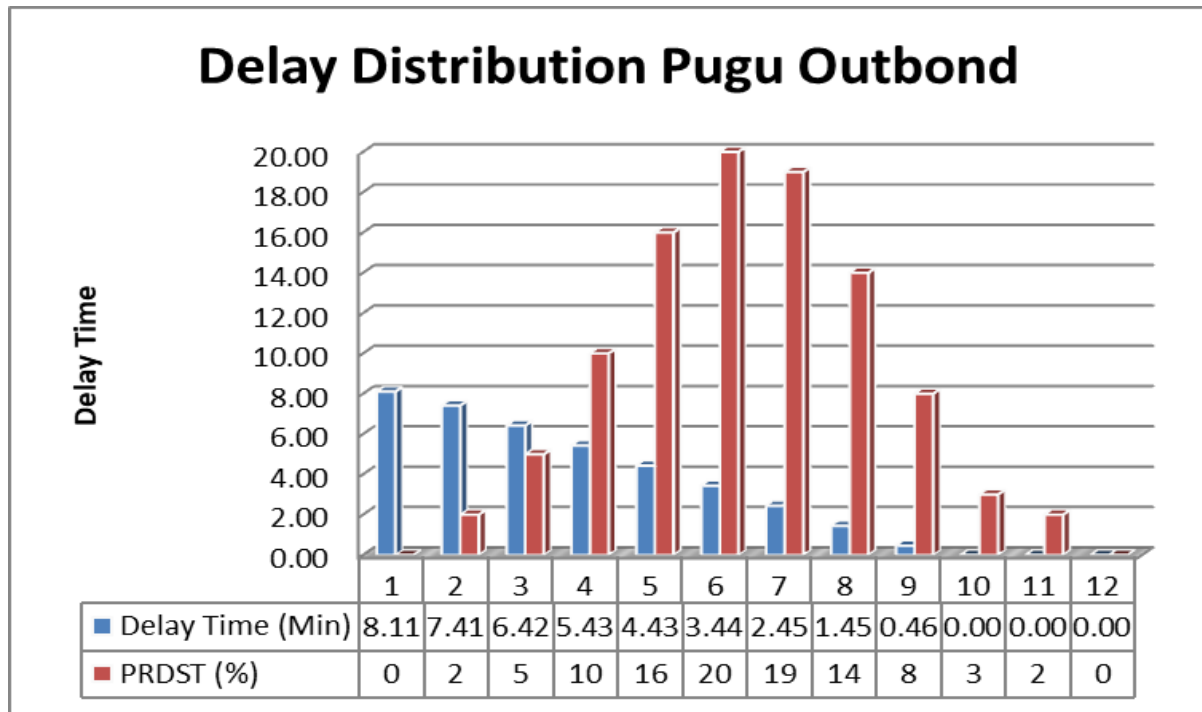
**Figure: 6.1(c)** Delay Distribution at Intersection off-Peak Outbound Direction



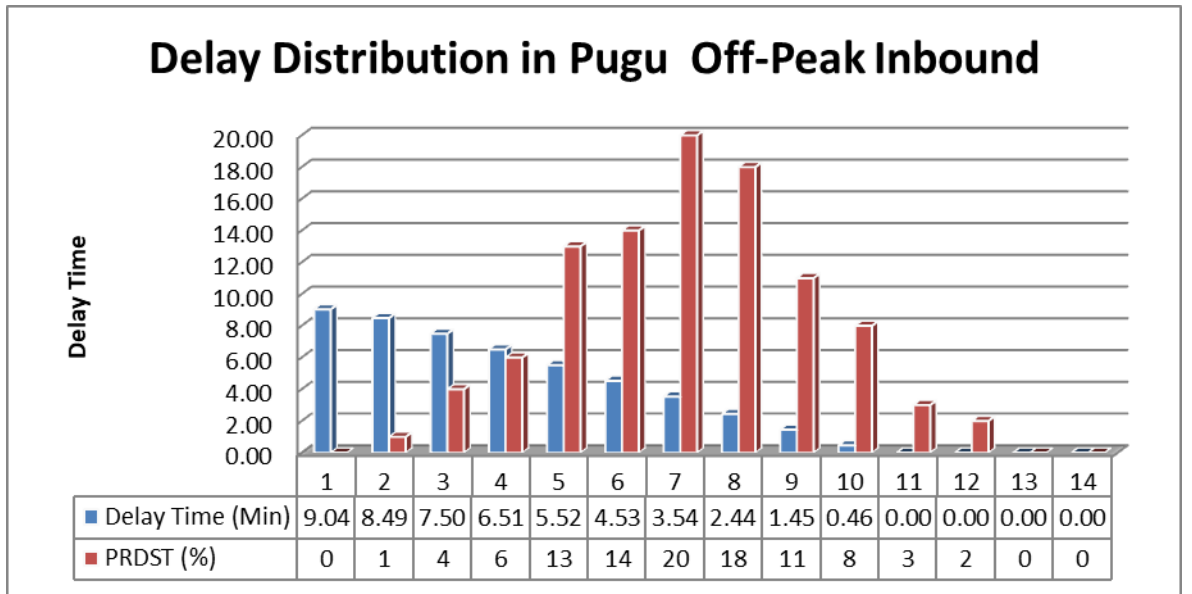
**Figure: 6.1(d)** Delay Distribution at Intersection Peak Outbound Direction



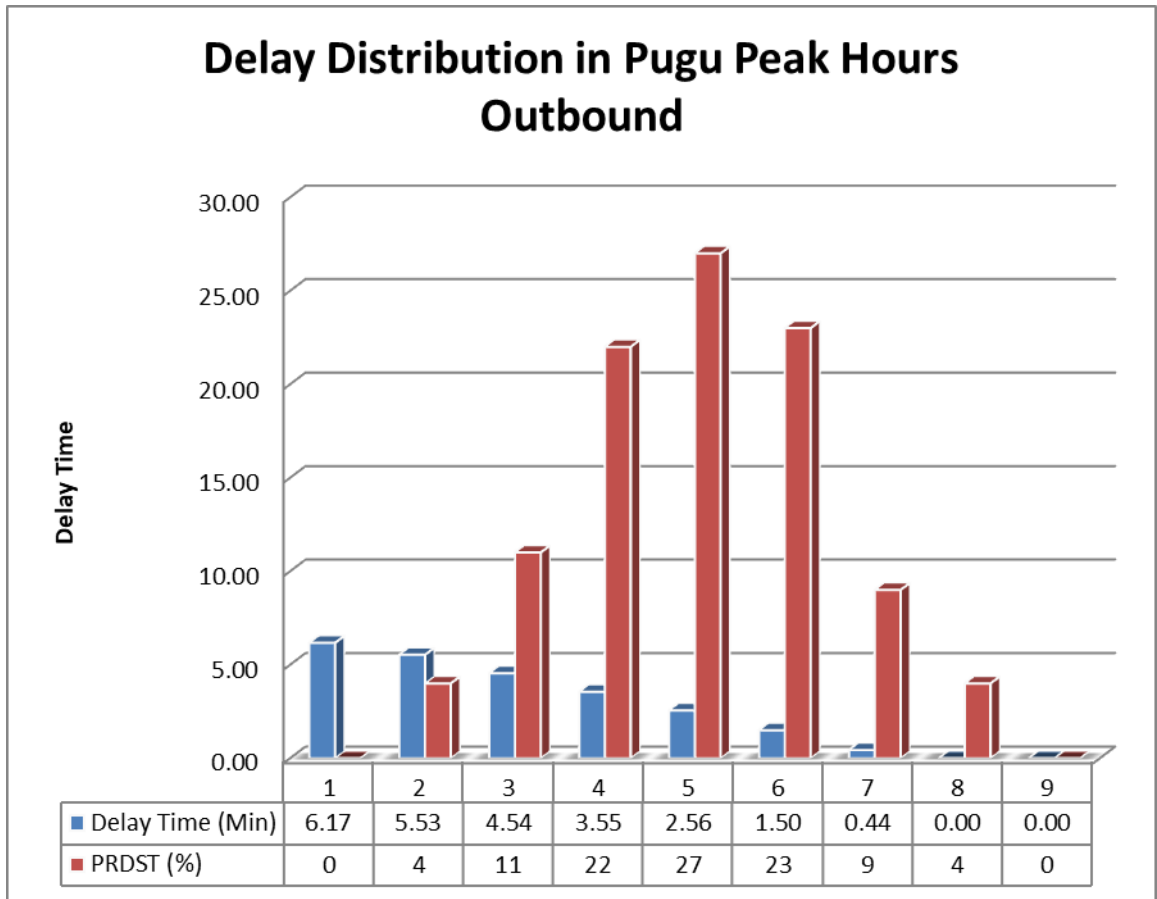
**Figure: 6.2(a)** Delay Distribution at Intersection Inbound Direction



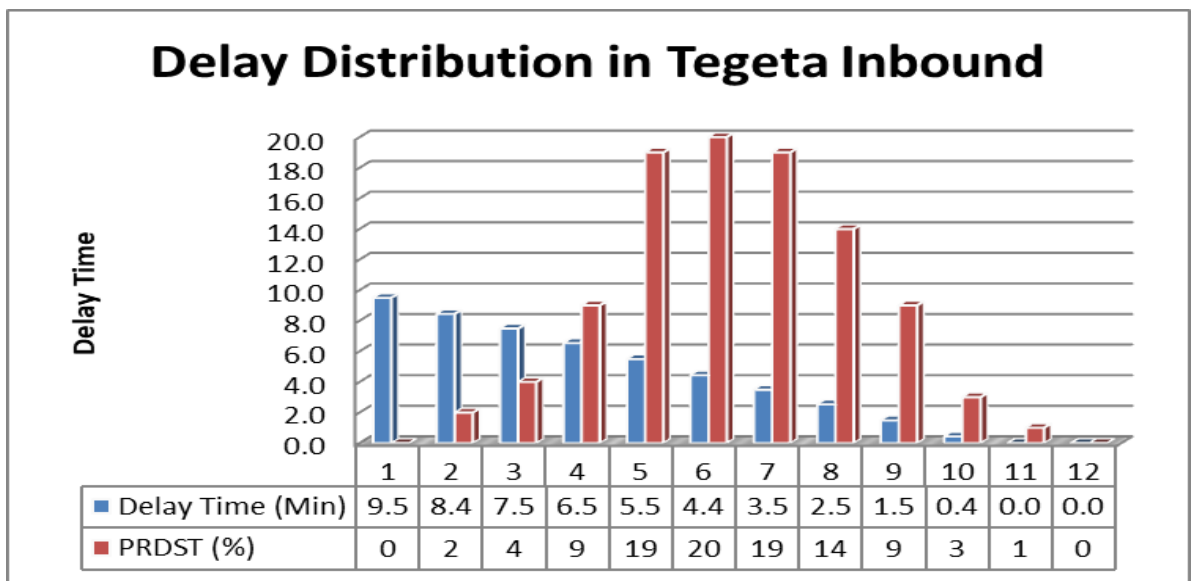
**Figure: 6.2(b)** Delay Distribution at Intersection Outbound Direction



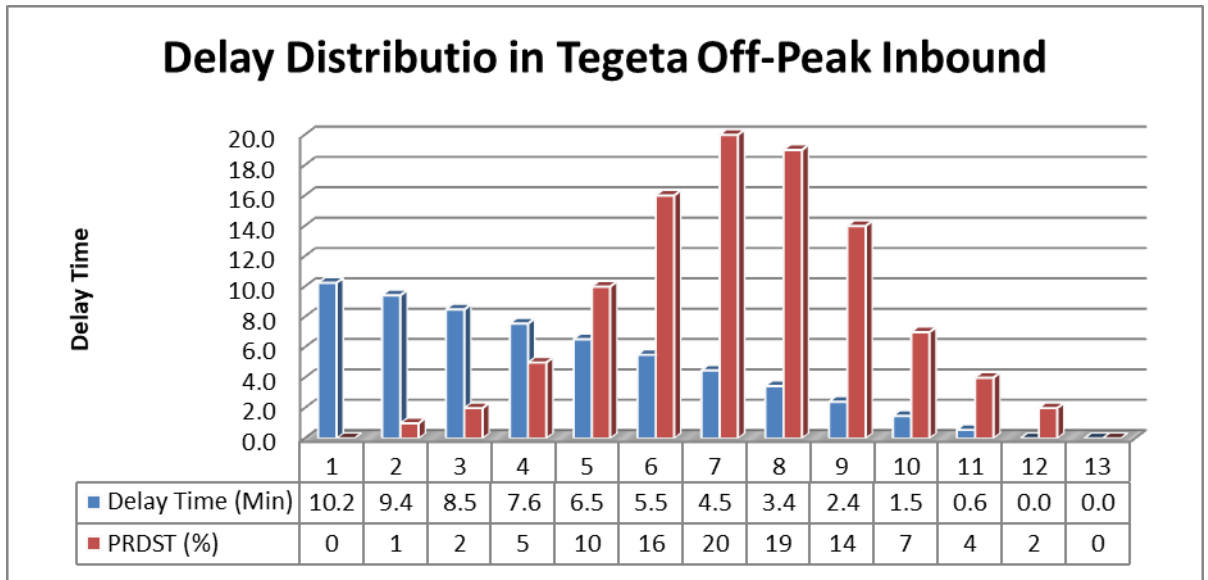
**Figure: 6.2(c)** Delay Distribution at Intersection Off-Peak Inbound Direction



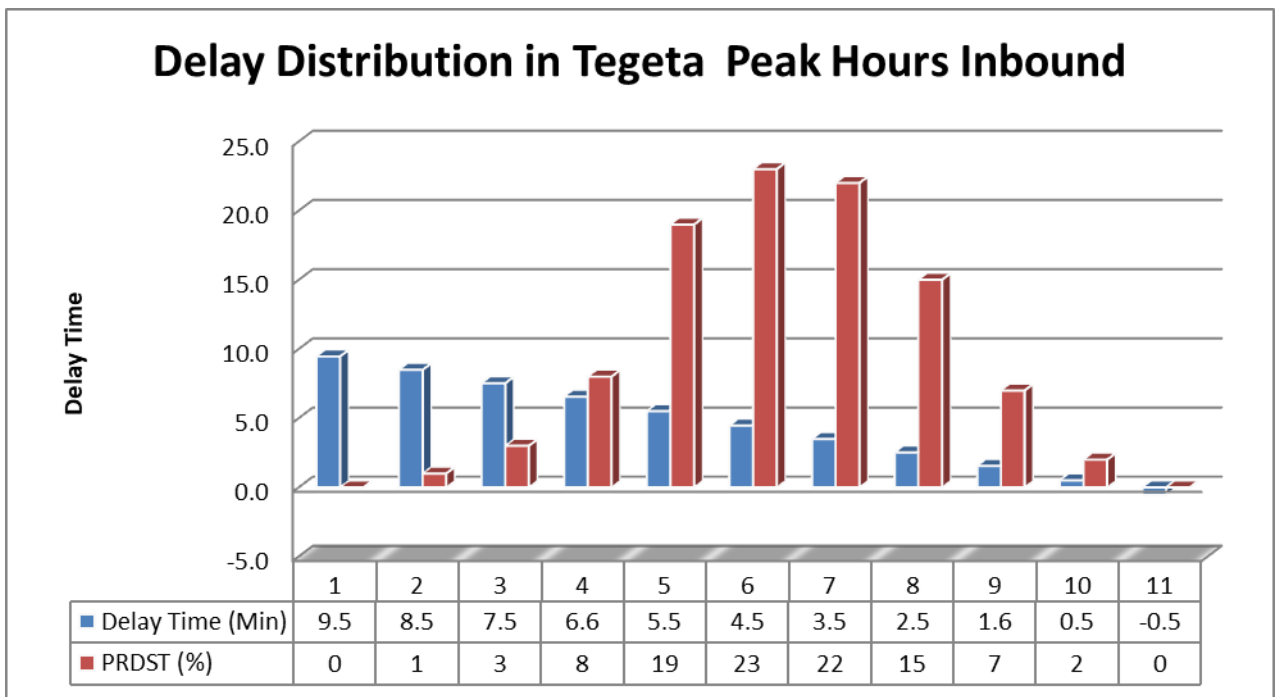
**Figure: 6.2(c)** Delay Distribution at Intersection Peak Inbound Direction



**Figure: 6.3(a)** Delay Distribution at Intersection Inbound Direction



**Figure: 6.3(b)** Delay Distribution at Intersection Off-Peak Inbound Direction



**Figure: 6.3(a)** Delay Distribution at Intersection Peak Inbound Direction

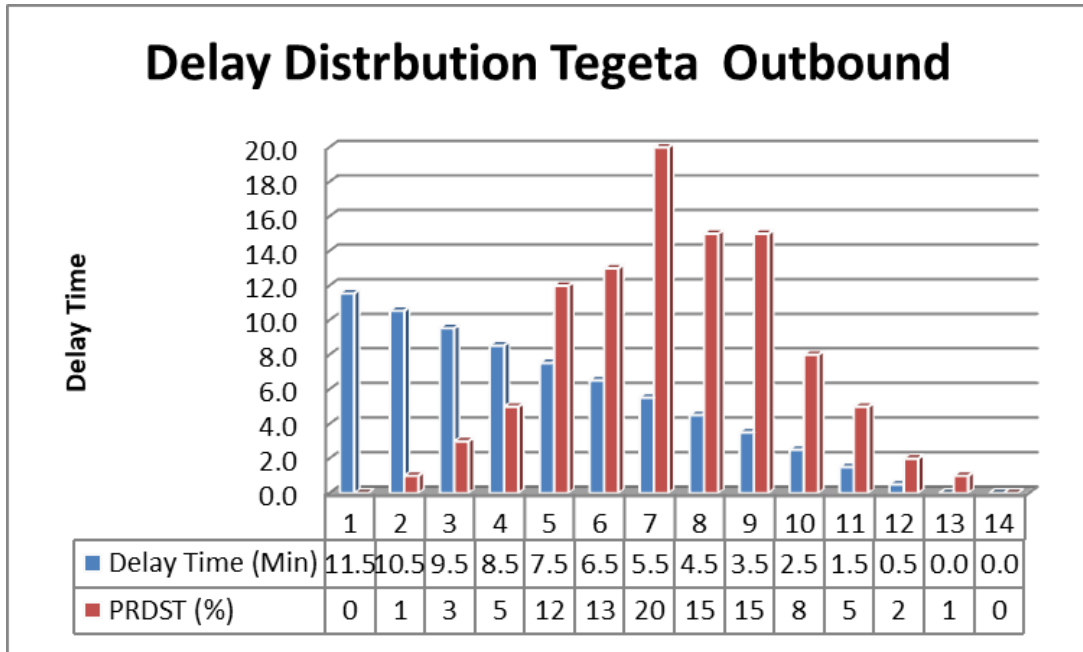


Figure: 6.3(c) Delay Distribution at Intersection Outbound Direction

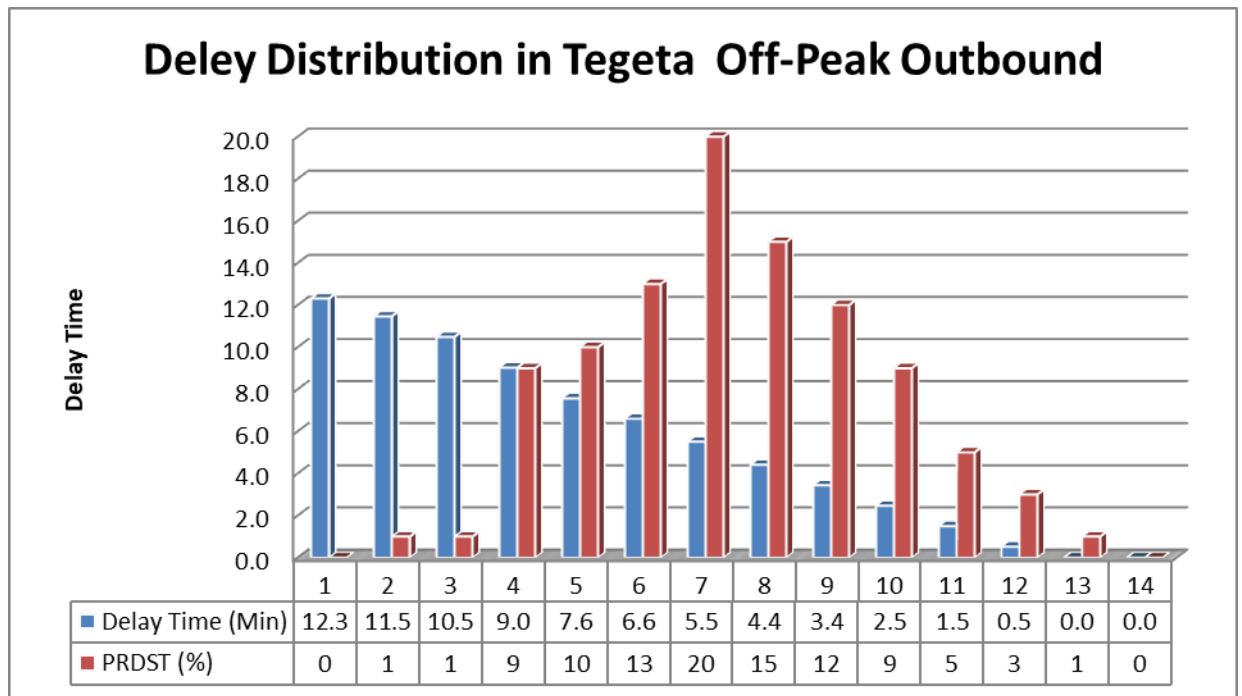
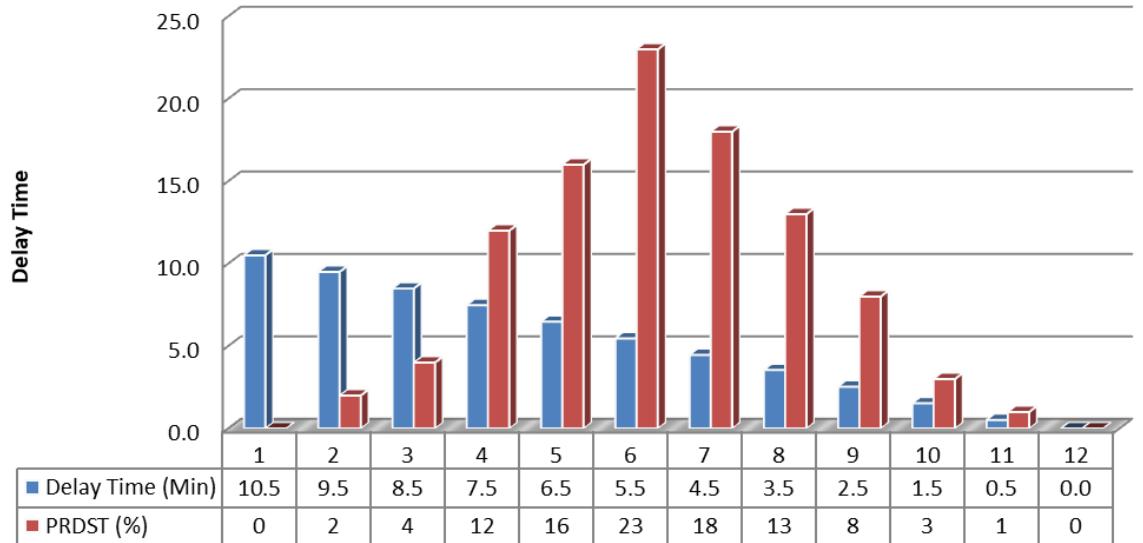
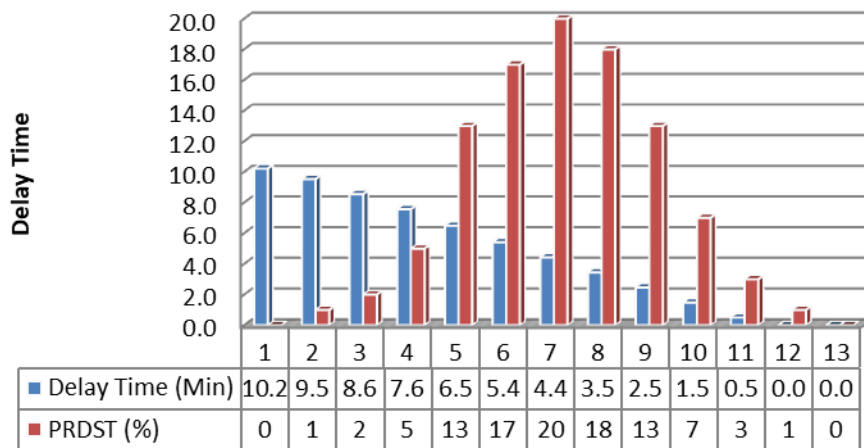


Figure: 6.3(d) Delay Distribution at Intersection Off-Peak Outbound Direction

### Delay Distribution in Tegeta Peak Hours Outbound

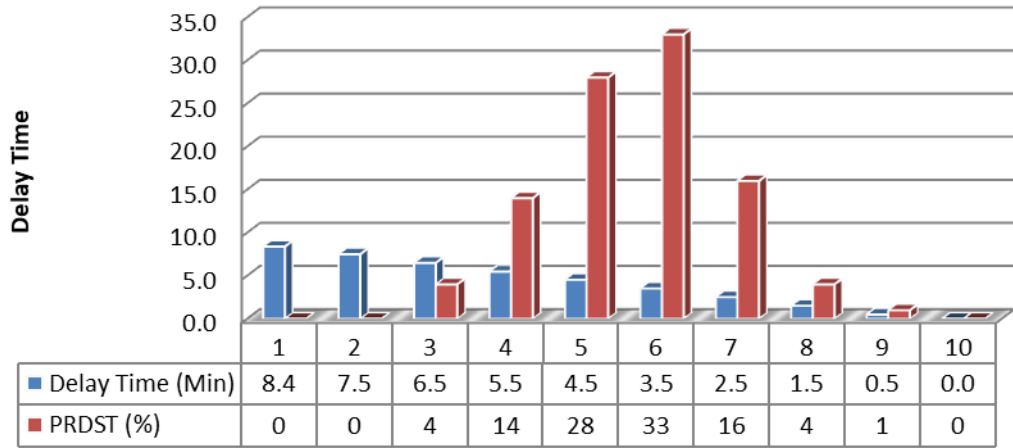


### Delay Distribution Mbezi Inbound

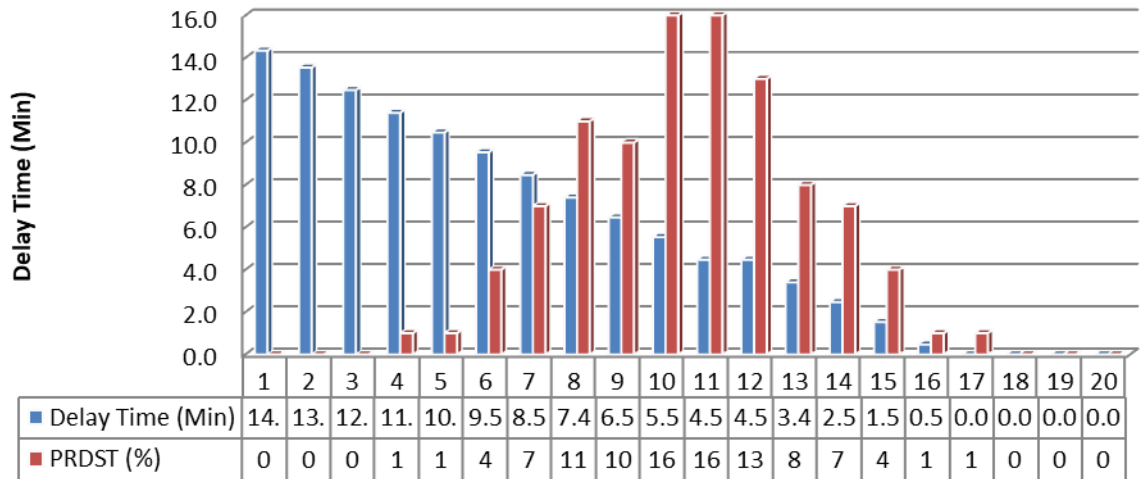




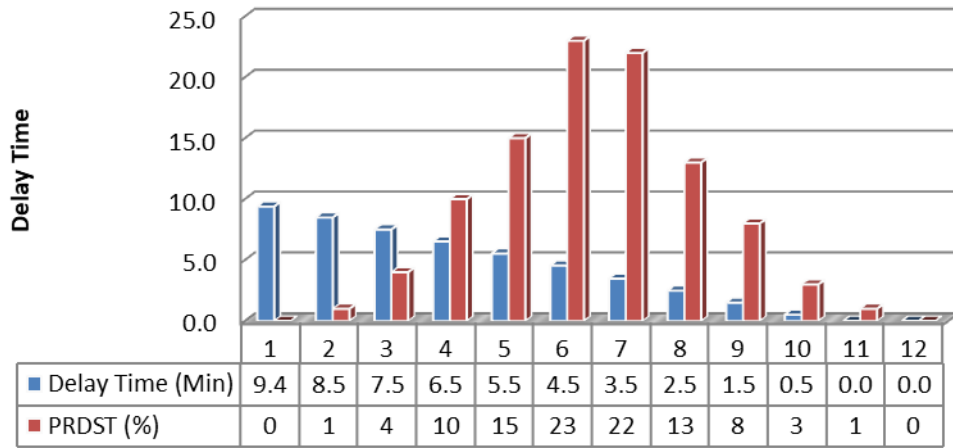
### Delay Distributio Mbezi Off-Peak Inbound



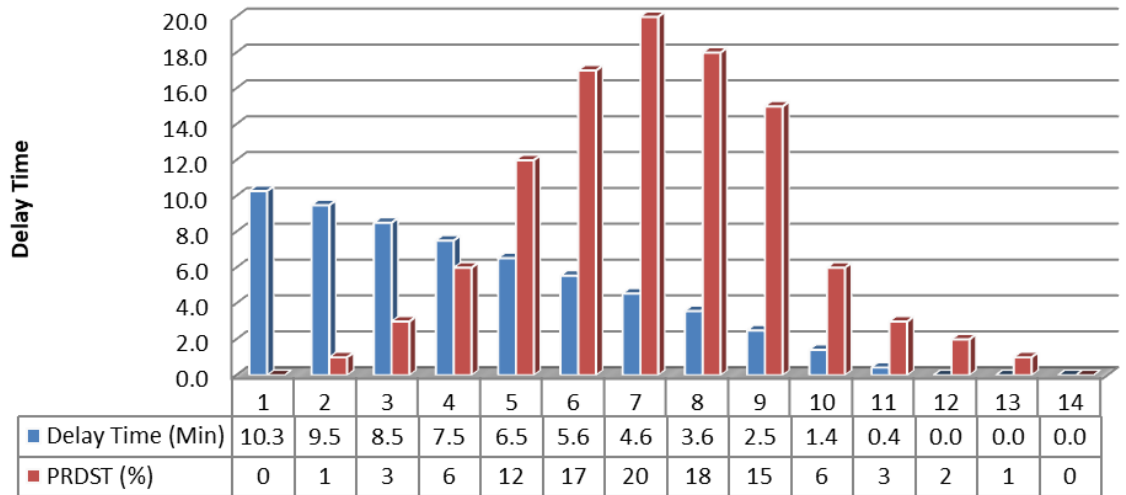
### Delay Distribution Mbezi Peak Hours Inbound



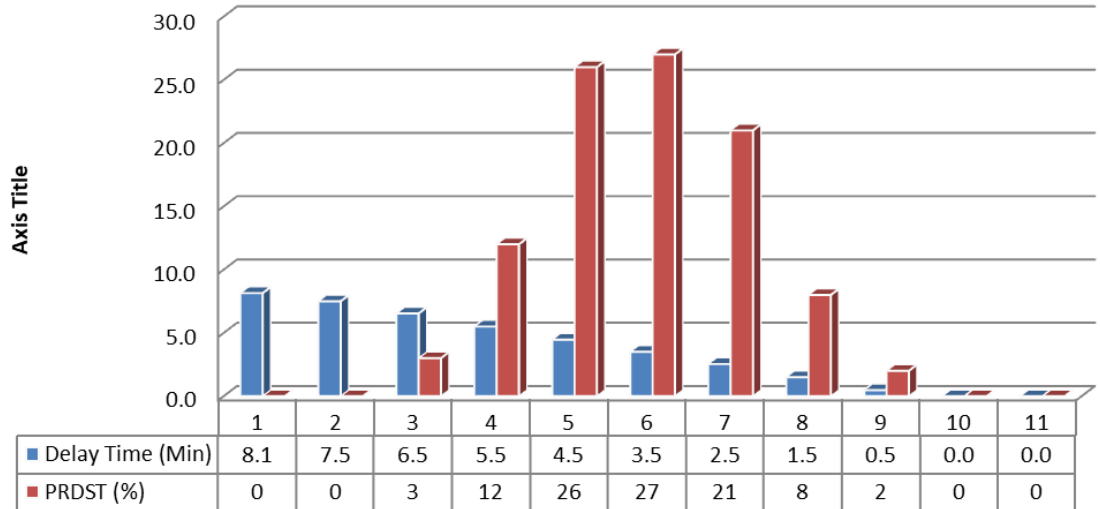
### Delay Distribution in Mbezi Outbound



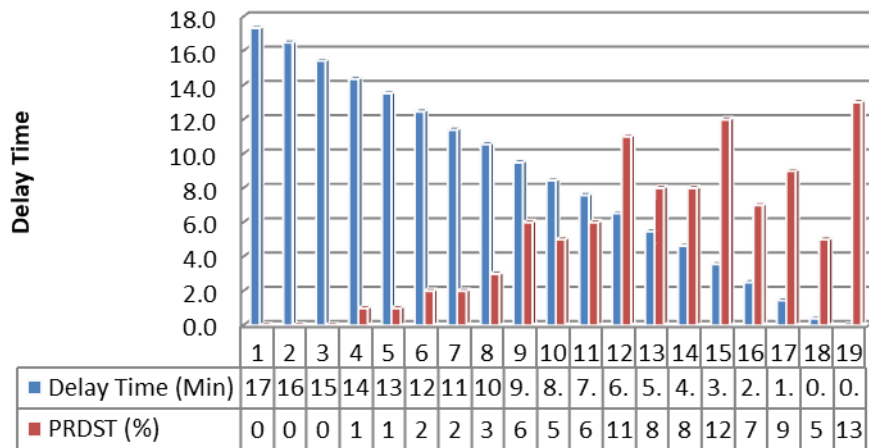
### Delay Distribution in Mbezi Off-Peak Outbound



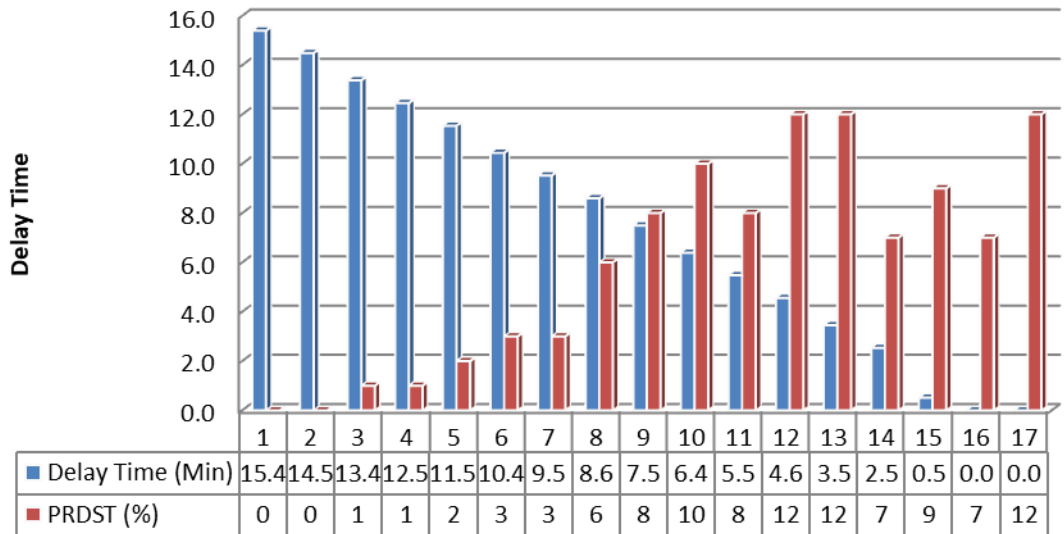
### Delay Distribution in Mbezi Peak Hours Outbound



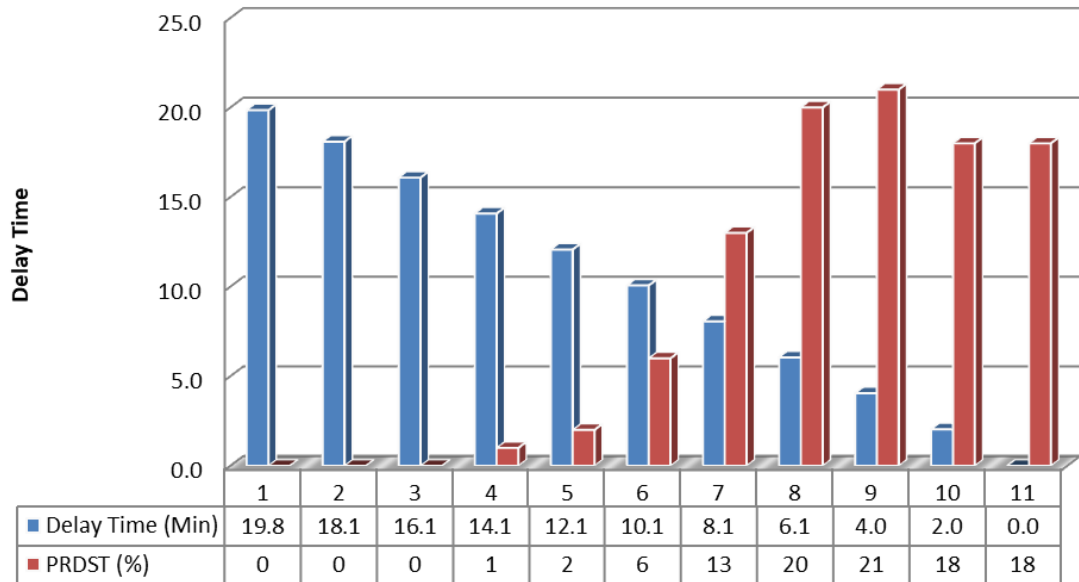
### Delay Distribution in Kawe Inbound



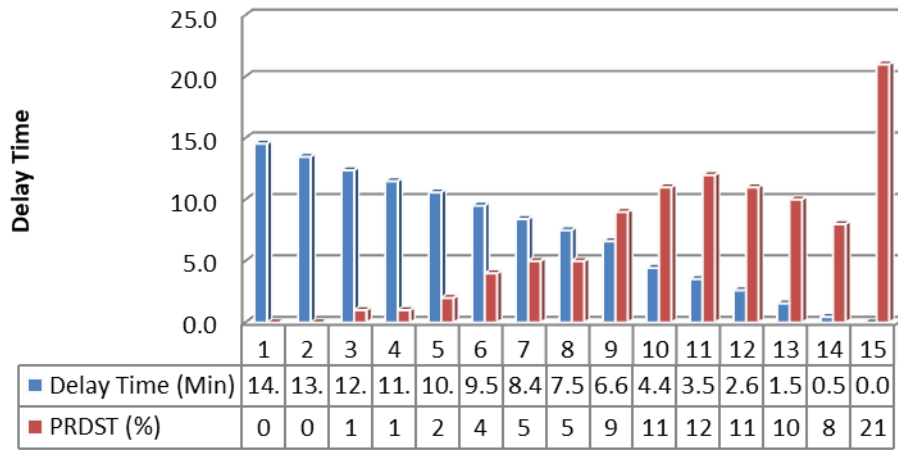
### Delay Distribution in Kawe Off-Peak Inbound



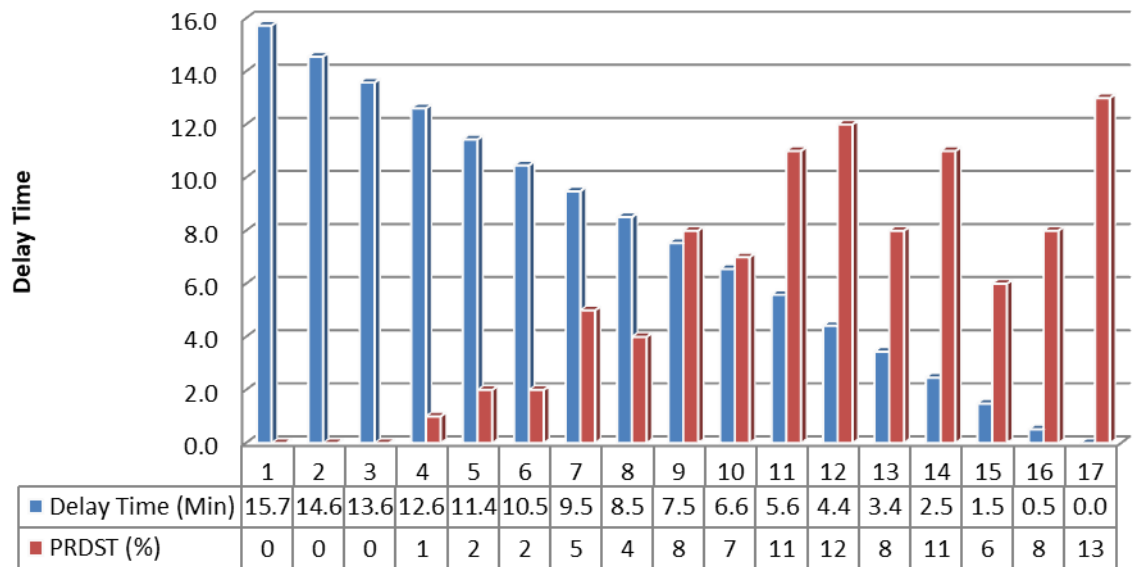
### Delay Distribution in Kawe Peak Hours Inbound



### Delay Distribution in Kawe Outbound



### Delay Distribution in Kawe Off\_Peak Outbound



### Delay Distribution in Kawe Peak Hours Outbound

